

Micro Motion™ ELITE™ Coriolis Flow and Density Meters



Ultimate real world performance

- Unchallengeable ELITE performance on liquid mass flow, volume flow, and density measurements
- Best-in-class gas mass flow measurement
- Reliable two-phase flow measurement for the most challenging applications
- Designed to minimize process, mounting, and environmental effects

[VIEW PRODUCT >](#)

Best fit-for-application

- Scalable platform for the widest range of line size and application coverage including hygienic, cryogenic, high pressure, and high temperature
- Available with the broadest range of communication and connectivity options

Superior measurement confidence

- Smart Meter Verification™ delivers complete, traceable calibration verification, continuously or on-demand at the press of a button
- Globally leading ISO/IEC 17025 calibration facilities offers best in class uncertainty of $\pm 0.014\%$
- Intelligent sensor design mitigates the need for zero calibration in the field

Micro Motion ELITE Coriolis flow and density meters

ELITE meters provide unmatched flow and density measurement performance to deliver the ultimate control and confidence in your most complex and challenging liquid, gas, and slurry applications.

Ultimate flow measurement solutions for your unique application requirements

- Able to achieve the best fit for your flow measurement with a wide range of tube designs and flow rate coverage to best serve your application
- Peak performance in a drainable design with a variety of industry approvals for use in strictly governed or regulated applications
- Scalable platform for a broad array of application coverage including hygienic, cryogenic, high temperature, and high pressure

Smart Meter Verification™: advanced diagnostics for your entire system

- Included as standard, with the option to license flow range detection and other advanced meter health diagnostics
- A comprehensive test that can be scheduled, run locally, or from the control room to provide confidence in your meter functionality and performance
- Verifies that your meter performs as well as the day it was installed, giving you assurance in less than 90 seconds
- Saves significant expenditure by reducing labor and extending or eliminating calibration intervals without interrupting the process

Industry-leading capabilities that unleash your process potential

- Available with the most extensive offering of transmitter and mounting options for maximum compatibility with your system
- State of the art, ISO-IEC 17025 compliant calibration stands achieving $\pm 0.014\%$ uncertainty drive best in class measurement accuracy
- The most robust communication protocol offering in the industry including Smart Wireless
- True multivariable technology measures flow, density, and process temperature simultaneously
- Widest selection of safety, country, and custody transfer approvals

Unparalleled performance in two-phase flow conditions

- Featuring the lowest frequency Coriolis sensors that ensure the two-phase mixture vibrates with the tube to drastically reduce uncertainty contributions from both the presence of liquid in a gas flow measurement, and entrained gas or aeration in liquid flow
- Unmatched MVD™ transmitter technology with digital signal processing (DSP) delivers the fastest response and refresh rates enabling accurate batch and other two-phase flow measurement
- Advanced software options for improved long-term flow reporting of concentration, net oil, and/or Gas Void Fraction (GVF) during two-phase flow conditions

Measurement principles

As a practical application of the Coriolis effect, the Coriolis mass flow meter operating principle involves inducing a vibration of the flow tube through which the fluid passes. The vibration, though it is not completely circular, provides the rotating reference frame which gives rise to the Coriolis effect. While specific methods vary according to the design of the flow meter, sensors monitor and analyze changes in frequency, phase shift, and amplitude of the vibrating flow tubes. The changes observed represent the mass flow rate and density of the fluid.

Mass and volume flow measurement

The measuring tubes are forced to oscillate producing a sine wave. At zero flow, the two tubes vibrate in phase with each other. When flow is introduced, the Coriolis forces cause the tubes to twist resulting in a phase shift. The time difference between the waves is measured and is directly proportional to the mass flow rate. Volume flow rate is calculated from mass flow rate and the density measurement.

Watch this video to learn more about how a Coriolis flow meter measures mass flow and density (click the link and select **View Videos**): <https://www.emerson.com/en-us/automation/measurement-instrumentation/flow-measurement/coriolis-flow-meters>.

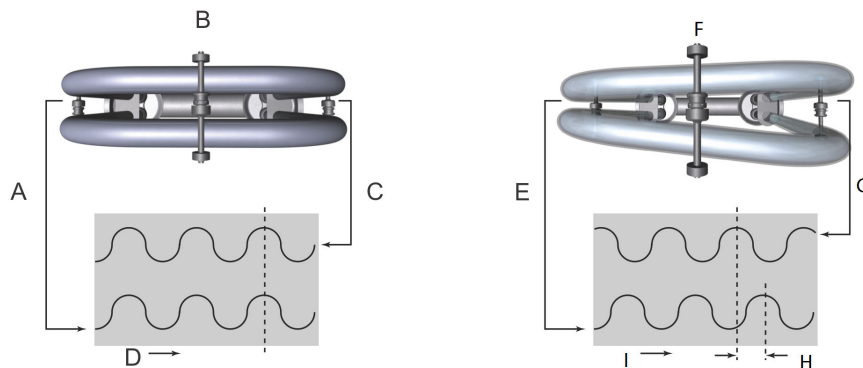

- A. Inlet pickoff displacement
- B. No flow
- C. Outlet pickoff displacement
- D. Time
- E. Inlet pickoff displacement
- F. With flow
- G. Outlet pickoff displacement
- H. Time difference
- I. Time

Density measurement

The measuring tubes are vibrated at their natural frequency. A change in the mass of the fluid contained inside the tubes causes a corresponding change to the tube natural frequency. The frequency change of the tube is used to calculate density.

Temperature measurement

Temperature is a measured variable that is available as an output. The temperature is also used internal to the sensor to compensate for temperature influences on Young’s Modulus of Elasticity.

Meter characteristics

- Measurement accuracy is a function of fluid mass flow rate independent of operating temperature, pressure, or composition. However, pressure drop through the sensor is dependent upon operating temperature, pressure, and fluid composition.
- Specifications and capabilities vary by model and certain models may have fewer available options. For detailed information regarding performance and capabilities, either contact customer service or visit www.emerson.com/flowmeasurement.
- All meters with the CMF designation (CMF, CMFHC, CMFS) are members of the ELITE meter family and should be considered to possess the same qualities and specifications as other ELITE family meters unless specifically noted.
- The letter at the end of the base model code (for example, CMF100M) represents wetted part material and/or application designation: M = 316L stainless steel, L = 304L stainless steel, H = nickel alloy C22, P = high pressure, A = high temperature 316L stainless steel, B = high temperature nickel alloy C22, Y = super duplex (UNS S32750). Detailed information about the complete product model codes are described later in this document.

Performance specifications

Reference operating conditions

For determining the performance capabilities of our meters, the following conditions were observed / utilized:

- Water at 68 °F (20 °C) to 77 °F (25 °C) and 14.5 psig (1.000 barg) to 29 psig (2.00 barg)
- Air and natural gas at 68 °F (20 °C) to 77 °F (25 °C) and 500 psig (34 barg) to 1,450 psig (100 barg)
- Accuracy based on industry leading accredited calibration standards according to ISO 17025/IEC 17025
- A density range up to 5 g/cm³ (5,000 kg/m³) on all models

Accuracy and repeatability

Accuracy and repeatability on liquids and slurries

Performance specification	Premium option ⁽¹⁾	Standard option
Mass/volume flow accuracy ⁽²⁾⁽³⁾	±0.05% of rate	±0.10% of rate
Mass/volume flow repeatability	0.025% of rate	0.05% of rate
Density accuracy ⁽²⁾⁽⁴⁾	±0.0002 g/cm ³ (±0.2 kg/m ³)	±0.0005 g/cm ³ (±0.5 kg/m ³)
Density repeatability	0.0001 g/cm ³ (0.1 kg/m ³)	0.0002 g/cm ³ (0.2 kg/m ³)

(1) Not available on all models

(2) For cryogenic applications with process temperatures below -148 °F (-100.0 °C), the liquid mass flow accuracy is ±0.35% of rate, mass flow linearity is ±0.05% of rate, and density accuracy specification does not apply.

(3) Stated flow accuracy includes the combined effects of repeatability, linearity, hysteresis, orientation and other non-linearities.

(4) The standard density accuracy option for CMFS007, CMFS010, and CMFS015 is ±0.002 g/cm³ (±2 kg/m³). The premium density accuracy option for CMFS010 and CMFS015 is ±0.0005 g/cm³ (±0.5 kg/m³).

Accuracy and repeatability on gases

Performance specification	Standard models
Mass flow accuracy ⁽¹⁾	±0.25% of rate
Mass flow repeatability	0.20% of rate
Mass flow linearity	±0.05% of rate up to a 0.2 Mach number
Accuracy with gas calibration linearization ⁽²⁾	±0.1% of rate after Piecewise Linearization (PWL) adjustment

(1) Stated flow accuracy includes the combined effects of repeatability, linearity, hysteresis, orientation and other non-linearities.

(2) Gas calibration at a third-party gas lab can either be managed by the customer after meter delivery or requested as part of the quote process. PWL and gas calibration specification reflects expected AS-LEFT linearized results relative to the gas lab reference standards. Actual results may vary depending on the uncertainty and stability of the gas lab reference standards applied.

Accuracy and repeatability on temperature

Performance specification	Standard models
Temperature accuracy	±1 °C ±0.5% of reading; BS1904 Class, DIN43760 Class A (±0.15 + 0.002 x T °C)
Temperature repeatability	0.2 °C
Environmental temperature compensation ⁽¹⁾	BS1904 Class, DIN 43760 Class B (±0.30 + 0.005 x T °C) - Qty 3 case sensors

(1) Not available on all models.

Warranty**Warranty options on all ELITE models**

The warranty period is generally initiated from the day of shipment. For warranty details, see the *Terms and Conditions* included with the standard product quote.

Base model	Included as standard	Included with startup service	Available for purchase
CMF, CMFS, and CMFHC	18 months	36 months	> 36 months (customizable length)

Liquid flow rates**Nominal flow rate**



Micro Motion uses the term *nominal flow rate*. Nominal flow rate is the flow rate at which water at reference conditions causes approximately 14.5 psig (1.000 barg) of pressure drop across the meter.

Mass flow rates for stainless steel models: 304L (L), 316L (M/A), and super duplex (Y)

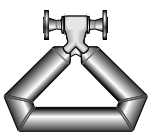
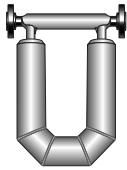
Style	Model	Nominal line size		Nominal flow rate		Maximum flow rate	
		inch	mm	lb/min	kg/h	lb/min	kg/h
	CMFS007M	0.08	DN1	1.28	35.0	1.50	40.9
	CMFS010M	0.1	DN2	3.56	97.0	4.03	110
	CMFS015M	0.17	DN3	11.4	310	12.1	330

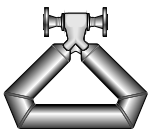

Style	Model	Nominal line size		Nominal flow rate		Maximum flow rate	
		inch	mm	lb/min	kg/h	lb/min	kg/h
	CMFS025M	0.25	DN6	41	1116	77.0	2100
	CMFS040M	0.38	DN10	85.0	2,320	170	4,640
	CMFS050M	0.5	DN15	133	3,614	250	6,820
	CMFS075M	0.75	DN20	230	6,270	460	12,500
	CMFS100M	1	DN25	534	14,524	950	25,900
	CMFS150M	1.5	DN40	990	27,000	1,980	54,000
	CMF010M/L	0.1	DN2	3.43	93.5	3.96	108
	CMF025M/L	0.25	DN6	48.0	1,310	79.9	2,180
	CMF050M/L	0.5	DN15	151	4,121	249	6,800
	CMF100M/L	1	DN25	602	16,372	997	27,200
	CMF200M/L/A	2	DN50	1,760	47,900	3,190	87,100
	CMF300M/L/A	3	DN80	6,017	163,755	9,970	272,000
	CMF350M/A	4	DN100	10,837	294,931	15,000	409,000
	CMF400M/A	4 to 6	DN100- DN150	15,255	415,179	20,000	545,000
	CMFHC2M/Y	6 to 8	DN150- DN200	33,224	904,211	54,000	1,470,000
	CMFHC3M/Y	8 to 10	DN200- DN250	58,949	1,604,333	94,000	2,550,000
	CMFHC4M	10 to 14	DN250- DN350	87,799	2,389,527	120,000	3,266,000

Mass flow rates for nickel alloy C22 (H/B) and high pressure (P) models

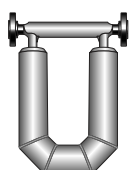

Style	Model	Nominal line size		Nominal flow rate		Maximum flow rate	
		inch	mm	lb/min	kg/h	lb/min	kg/h
	CMFS010H/P	0.1	DN2	2.86	78.0	4.03	110
	CMFS015H/P	0.17	DN3	8.18	223	12.1	330
	CMFS025H/P	0.25	DN6	35.0	945	65.0	1,770
	CMFS050H/P	0.5	DN15	100.0	2,720	188	5,130
	CMFS100H/P	1	DN25	482	13,125	860	23,500
	CMFS150H/P	1.5	DN40	900	24,500	1,800	49,100
	CMF010H/P	0.1	DN2	2.57	70.2	3.96	108
	CMF025H	0.25	DN6	48	1,310	79.9	2,180
	CMF050H	0.5	DN15	151	4,121	249	6,800
	CMF100H	1	DN25	602	16,372	997	27,200

Style	Model	Nominal line size		Nominal flow rate		Maximum flow rate	
		inch	mm	lb/min	kg/h	lb/min	kg/h
	CMF200H/B	2	DN50	1,760	47,900	3,190	87,100
	CMF300H/B	3	DN75	6017	163,755	9,970	272,000
	CMF350P	4	DN100	10,837	294,931	15,000	409,000
	CMF400H/B/P	4 - 6	DN100- DN150	15,255	415,179	20,000	545,000

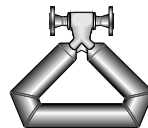
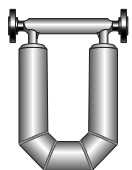
Volume flow rates for stainless steel models: 304L (L), 316L (M/A), and super duplex (Y)

Style	Model	Nominal flow rate			Maximum flow rate		
		gal/min	barrels/h	l/h	gal/min	barrels/h	l/h
	CMFS007M	0.154	0.220	35.0	0.180	0.257	40.9
	CMFS010M	0.426	0.609	97.0	0.484	0.691	110
	CMFS015M	1.36	1.95	310	1.45	2.07	330
	CMFS025M	5	7	1,119	9.23	13.2	2,100
	CMFS040M	10.2	14.6	2,320	20.4	29.1	4,640
	CMFS050M	16.0	23	3,627	30.0	42.8	6,820
	CMFS075M	27.6	39.4	6,270	55.2	78.8	12,500
	CMFS100M	64.0	91.0	14,576	114	163	25,900
	CMFS150M	119	170	27,000	237	339	54,000
	CMF010M/L	0.411	0.587	93.5	0.475	0.678	108
	CMF025M/L	5.76	8.23	1,310	9.58	13.7	2,180
	CMF050M/L	18.0	26.0	4,136	29.9	42.7	6,800
	CMF100M/L	72.0	103.0	16,430	120	171	27,200
	CMF200M/L/A	211	301	47,900	383	547	87,100
	CMF300M/L/A	721	1,029	164,338	1,200	1,710	272,000
	CMF350M/A	1,298	1,852	295,981	1,800	2,570	409,000
	CMF400M/A	1,827	2,608	416,657	2,400	3,420	545,000
	CMFHC2M/Y	3,978	5679	907,429	6,440	9,200	1,470,000
	CMFHC3M/Y	7,059	10,077	1,610,044	11,270	16,100	2,550,000
	CMFHC4	10,514	15,008	2,398,033	14,350	20,500	3,266,000

Volume flow rates for nickel alloy C22 (H/B) and high pressure (P) models

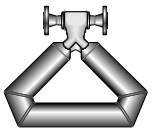
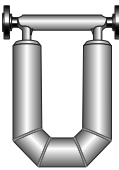
Style	Model	Nominal flow rate			Maximum flow rate		
		gal/min	barrels/h	l/h	gal/min	barrels/h	l/h
	CMFS010H/P	0.343	0.490	78.0	0.484	0.691	110
	CMFS015H/P	0.980	1.40	223	1.45	2.07	330
	CMFS025H/P	4	6	948	7.79	11.1	1,770
	CMFS050H/P	12	17	2,729	22.5	32.2	5,130
	CMFS100H/P	58	82	13,171	103	147	23,500
	CMFS150H/P	108	154	24,500	216	308	49,100
	CMF010H/P	0.309	0.441	70.2	0.475	0.678	108
	CMF025H	5.76	8.23	1,310	9.58	13.7	2,180
	CMF050H	18	26	4,136	29.9	42.7	6,800
	CMF100H	72	103	16,430	120	171	27,200
	CMF200H/B	211	301	47,900	383	547	87,100
	CMF300H/B	721	1,029	164,338	1,200	1,710	272,000
	CMF350P	1,298	1,852	295,981	1,800	2,570	409,000
	CMF400H/B/P	1,827	2,608	416,657	2,400	3,420	545,000

Gas flow rates

When selecting sensors for gas applications, pressure drop and turndown through the sensor is dependent upon operating temperature, pressure, and fluid composition. Therefore, when selecting a sensor for any particular gas application, it is highly recommended that each sensor be sized using the sizing and selection tool at www.emerson.com/flowmeasurement that will report both the actual velocity and the sonic velocity for each flow rate and meter size considered.

Use the following equation to determine general recommendations on nominal and maximum gas mass flow rates:

$$\dot{m}_{(gas)} = \%M * \rho_{(gas)} * VOS * \frac{1}{4} \pi * D^2 * 2 \text{ (for sensors with dual-tube design)}$$

- $\dot{m}_{(gas)}$ Gas mass flow rate
- $\%M$ Use Mach number “0.2” for calculating typical nominal rate; use Mach number “0.3” for calculating maximum recommended rate. When Mach Numbers are above 0.3, most gas flows become compressible and significant increases in pressure drop may occur regardless of measurement device.
- $\rho_{(gas)}$ Gas density at operating conditions
- VOS Velocity of Sound of the measured gas
- D Internal diameter of the measuring tube
For a complete list of sensor tube IDs, see the *Micro Motion ELITE Coriolis Flow and Density Meters Technical Data Sheet*.

Note

Gas maximum flow rate can never be greater than the maximum liquid rate. Assume that the lower of the two rates is applicable.

Sample calculation

The following calculation is an example of the maximum recommended gas mass flow rate for a CMF300M measuring natural gas with a molecular weight of 19.5 at 60 °F (16 °C) and 500 psig (34.47 barg):

$$\dot{m}_{(gas)} = 0.3 * 24(kg/m^3) * 430(m/s) * \frac{1}{4}\pi * .0447m^2 * 2$$

$$\dot{m}_{(gas)} = 34,988 \text{ kg/hr; maximum recommended rate for CMF300M with natural gas at given conditions}$$

- %M** 0.3 (used for calculating maximum recommended rate)
- Gas density** 24 kg/m³
- VOS_(NG)** 430 m/s (Velocity of Sound of natural gas at given conditions)
- CMF300M tube ID** 44.7 mm

Zero stability

Zero stability is used when the flow rate approaches the low end of the flow range where the meter accuracy begins to deviate from the stated accuracy rating, as depicted in the turndown section. When operating at flow rates where meter accuracy begins to deviate from the stated accuracy rating, accuracy is governed by the formula: accuracy = (zero stability/flow rate) x 100%. Repeatability is similarly affected by low flow conditions.

Turndown

The graph and table below represent an example of the measurement characteristics under various flow conditions. At flow rates requiring large turndowns (greater than 30:1), the zero stability values may begin to govern capability dependent upon flow conditions and meter in use.

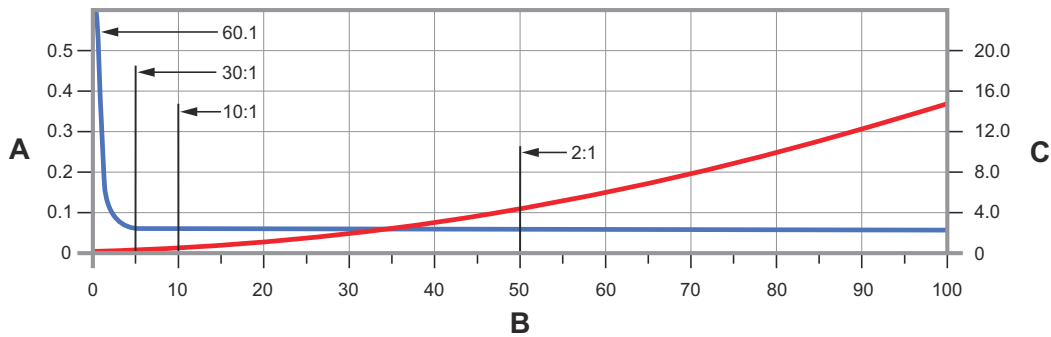

- A. Accuracy, % (blue line)
- B. Flow rate, % of nominal
- C. Pressure drop; psig, barg (red line)

Sample of accuracy and pressure drop across flow rate

Turndown from nominal flow rate	60:1	30:1	10:1	2:1	1:1
Accuracy ±%	0.25	0.05	0.05	0.05	0.05
Pressure drop	0.008 psig (0.00055 barg)	0.06 psig (0.0041 barg)	0.22 psig (0.0152 barg)	4.11 psig (0.2834 barg)	14.5 psig (1.000 barg)

Zero stability for stainless steel models: 316L (M)

Model	Zero stability	
	lb/min	kg/h
CMFS007M	0.000043	0.0012
CMFS010M	0.000075	0.0020
CMFS015M	0.00030	0.0081
CMFS025M	0.00065	0.017
CMFS040M	0.0018	0.05
CMFS050M	0.0026	0.07
CMFS075M	0.0071	0.19
CMFS100M	0.012	0.33
CMFS150M	0.030	0.81

Zero stability for stainless steel models: 304L (L), 316L (A), and super duplex (Y)

Model	Zero stability	
	lb/min	kg/h
CMF010M/L	0.000078	0.0021
CMF025M/L	0.0010	0.027
CMF050M/L	0.0029	0.078
CMF100M/L	0.017	0.47
CMF200M/L/A	0.048	1.30
CMF300M/L/A	0.16	4.40
CMF350M/A	0.31	8.30
CMF400M/A	0.72	19.71
CMFHC2M/Y/A	1.08	29.45
CMFHC3M/Y/A	2.34	63.56
CMFHC4M	3.66	99.65

Zero stability values for nickel alloy C22 models (H/B)

Model	Zero stability	
	lb/min	kg/h
CMFS010H	0.00016	0.0044
CMFS015H	0.00042	0.011
CMFS025H	0.0013	0.036
CMFS050H	0.0037	0.10
CMFS100H	0.012	0.32
CMFS150H	0.035	0.96

Model	Zero stability	
	lb/min	kg/h
CMF010H	0.000075	0.0021
CMF025H	0.00090	0.025
CMF050H	0.0041	0.11
CMF100H	0.014	0.37
CMF200H/B	0.07	1.97
CMF300H/B	0.17	4.57
CMF400H/B	0.74	20.20

Zero stability values for high pressure (P) models

Model	Zero stability	
	lb/min	kg/h
CMFS010P	0.00017	0.0045
CMFS015P	0.00044	0.012
CMFS025P	0.0011	0.031
CMFS050P	0.0043	0.12
CMFS100P	0.012	0.34
CMFS150P	0.030	0.82
CMF010P	0.00016	0.0043
CMF350P	0.32	8.75
CMF400P	0.74	20.07

Process pressure ratings

Sensor maximum working pressure reflects the highest possible pressure rating for a given sensor. Process connection type and environmental and process fluid temperatures may reduce the maximum rating. For common sensor and fitting combinations, see the *Micro Motion ELITE Coriolis Flow and Density Meters Technical Data Sheet* at www.emerson.com/flowmeasurement.

All sensors comply with Council Directive 2014/68/EU on pressure equipment.

Some sensor models also comply with the ASME® B31.1 power piping design code as indicated with a pressure rating in the table. Sensors with JIS process connections do not comply with ASME B31.1 power piping code.

Sensor maximum working pressure for stainless steel models: 304L (L) and 316L (M/A)

Model	ASME B31.3 compliance	ASME B31.1 compliance
CMFS007M, CMFS010M	3,625 psig (249.93 barg)	n/a
CMFS015M	2,225 psig (153.41 barg)	n/a
CMFS025M, CMFS040M, CMFS050M, CMFS075M, CMFS100M, CMFS150M	1,500 psig (103.42 barg)	1,500 psig (103.42 barg)
CMF010M/L	1,812 psig (124.93 barg)	1,812 psig (124.93 barg)

Model	ASME B31.3 compliance	ASME B31.1 compliance
CMF025M/L, CMF050M/L	1,500 psig (103.42 barg)	1,500 psig (103.42 barg)
CMF100M/L	1,450 psig (99.97 barg)	1,450 psig (99.97 barg)
CMF200M/L/A	1,580 psig (108.94 barg)	1,580 psig (108.94 barg)
CMF300M/L/A	1,730 psig (119.28 barg)	1,730 psig (119.28 barg)
CMF350M/A	1,480 psig (102.04 barg)	1,480 psig (102.04 barg)
CMF400M/A	1,500 psig (103.42 barg)	1,500 psig (103.42 barg)
CMFHC2M/A	1,480 psig (102.04 barg)	1,470 psig (101.35 barg)
CMFHC3M/A	1,480 psig (102.04 barg)	1,460 psig (100.66 barg)
CMFHC4M	1,480 psig (102.04 barg)	n/a

Sensor maximum working pressure for nickel alloy C22 models (H/B)

Model	ASME B31.3 compliance	ASME B31.1 compliance
CMFS010H, CMFS015H	6,000 psig (413.69 barg)	n/a
CMFS025H, CMFS050H	3,626 psig (250.00 barg)	3,626 psig (250.00 barg)
CMFS100H, CMFS150H	3,626 psig (250.00 barg)	n/a
CMF010H	3,263 psig (224.98 barg)	n/a
CMF025H	2,755 psig (189.95 barg)	n/a
CMF050H	2,683 psig (184.99 barg)	n/a
CMF100H	2,465 psig (169.96 barg)	n/a
CMF200H/B	2,755 psig (189.95 barg)	n/a
CMF300H/B	2,683 psig (184.99 barg)	n/a
CMF400H/B	2,855 psig (196.85 barg)	n/a

Sensor maximum working pressure for high pressure models (P)

Model	ASME B31.3 compliance	ASME B31.1 compliance
CMFS010P, CMFS015P	6,000 psig (413.69 barg)	n/a
CMFS025P, CMFS050P	3,626 psig (250.00 barg)	3,626 psig (250.00 barg)
CMFS100P, CMFS150P	3,626 psig (250.00 barg)	n/a
CMF010P	6,000 psig (413.69 barg)	n/a
CMF350P	2,250 psig (155.13 barg)	n/a
CMF400P	2,973 psig (204.98 barg)	n/a

Sensor maximum working pressure for super duplex models (Y)

Model	ASME B31.3 compliance	ASME B31.1 compliance
CMFHC2Y, CMFHC3Y	2,320 psig (159.96 barg)	n/a

Case pressure

Case pressure for CMF models

Model	Case maximum pressure ⁽¹⁾	Typical burst pressure ⁽²⁾
CMF010	425 psig (29.30 barg)	3,042 psig (209.74 barg)
CMF025	850 psig (58.61 barg)	5,480 psig (377.83 barg)
CMF050	850 psig (58.61 barg)	5,286 psig (364.46 barg)
CMF100	625 psig (43.09 barg)	3,299 psig (227.46 barg)
CMF200	550 psig (37.92 barg)	2,786 psig (192.09 barg)
CMF300	275 psig (18.96 barg)	1,568 psig (108.11 barg)
CMF350	275 psig (18.96 barg)	2,092 psig (144.24 barg)
CMF400	250 psig (17.24 barg)	1,556 psig (107.28 barg)
CMFHC2	n/a	1,100 psig (75.84 barg)
CMFHC3	n/a	1,150 psig (79.29 barg)
CMFHC4	n/a	990 psig (68.26 barg)

(1) Derived from B31.3 international standards.

(2) Values do not apply for high-temperature models (base model codes A or B).

Case pressure for CMFS models

Model	Case maximum pressure ⁽¹⁾	Typical burst pressure
CMFS007	1,326 psig (91.42 barg)	5,302 psig (365.56 barg)
CMFS010, CMFS015	1,518 psig (104.66 barg)	6,072 psig (418.65 barg)
CMFS025, CMFS040, CMFS050	558 psig (38.47 barg)	2,230 psig (153.75 barg)
CMFS075, CMFS100, CMFS150	650 psig (44.82 barg)	2,598 psig (179.13 barg)

(1) Case maximum pressure is determined by applying a safety factor of 4 to typical burst pressure.

Operating conditions: Environmental

Vibration limits

Meets IEC 60068-2-6, endurance sweep, 5 to 2000 Hz up to 1.0 g.

Temperature limits

Sensors can be used in the process and ambient temperature ranges shown in the temperature limit graphs. For the purposes of selecting electronics options, temperature limit graphs should be used only as a general guide. If your process conditions are close to the gray area, consult with your Micro Motion representative.

Note

- In all cases, the electronics cannot be operated where the ambient temperature is below -40 °F (-40.0 °C) or above 140 °F (60.0 °C). If a sensor is to be used where the ambient temperature is outside of the range permissible for the electronics, the electronics must be remotely located where the ambient temperature is within the permissible range, as indicated by the shaded areas of the temperature limit graphs.

- Temperature limits may be further restricted by hazardous area approvals. Refer to the hazardous area approvals documentation shipped with the sensor or available at www.emerson.com/flowmeasurement.
- The extended-mount electronics option allows the sensor case to be insulated without covering the transmitter, core processor, or junction box, but does not affect temperature ratings. When insulating the sensor case at elevated process temperatures above 140 °F (60.0 °C), ensure electronics are not enclosed in insulation as this may lead to electronics failure.
- For the CMFS007 sensor, the difference between the process fluid temperature and the average temperature of the case must be less than 210 °F (99 °C)

Ambient and process temperature limits for CMFS007, CMFS025–CMFS150

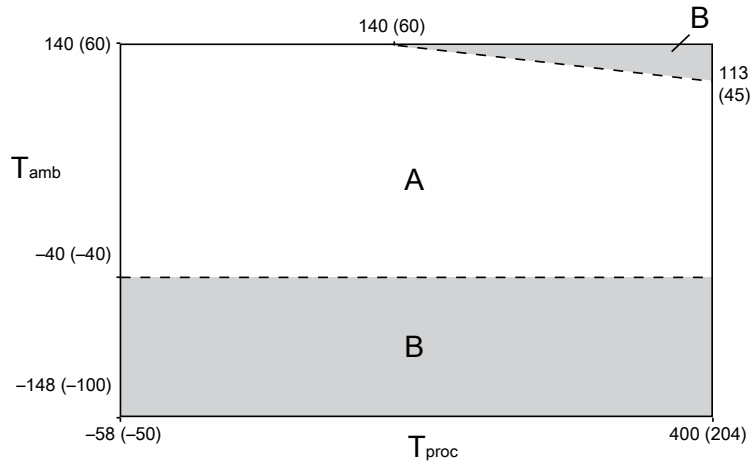

T_{amb} = Ambient temperature °F (°C)
 T_{proc} = Process temperature °F (°C)
 A = All available electronic options
 B = Remote mount electronics only

Ambient and process temperature limits for CMF*M/L/H/P (excludes special order cryogenic modifications) and CMFS010-015**

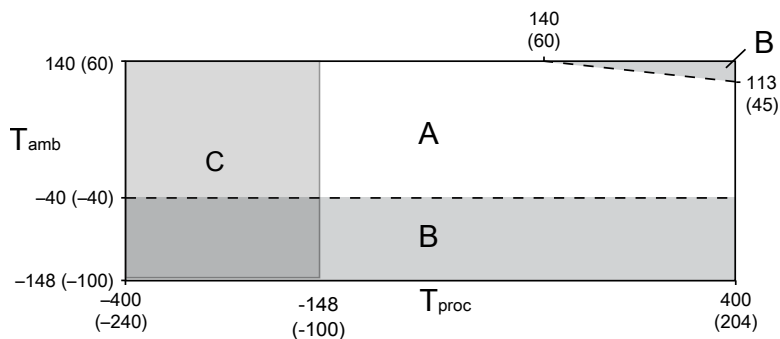

T_{amb} = Ambient temperature °F (°C)
 T_{proc} = Process temperature °F (°C)
 A = All available electronic options
 B = Remote mount electronics only
 C = Recommend special order cryogenic sensor options when operating at a process temperature below -148 °F (-100 °C)

Ambient and process temperature limits for special order cryogenic ELITE meters

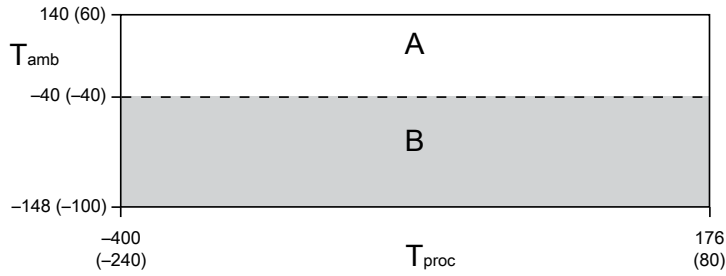

T_{amb} = Ambient temperature °F (°C)
 T_{proc} = Process temperature °F (°C)
 A = All available electronic options
 B= Remote mount electronics only

Ambient and process temperature limits for high temperature ELITE meters

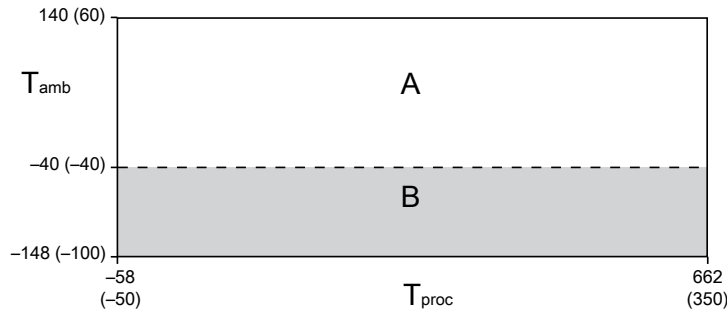

T_{amb} = Ambient temperature °F (°C)
 T_{proc} = Process temperature °F (°C)
 A = All available electronic options
 B= Remote mount electronics only

Ambient and process temperature limits for super duplex ELITE meters

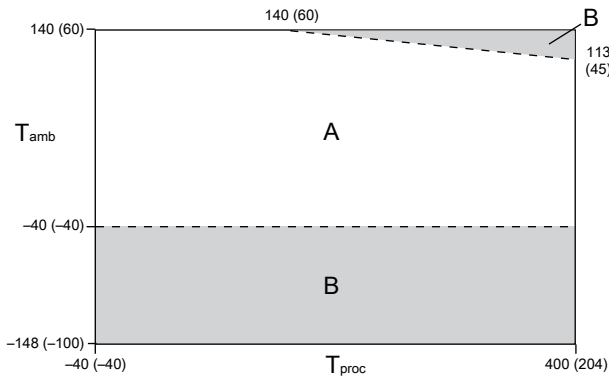

T_{amb} = Ambient temperature °F (°C)
 T_{proc} = Process temperature °F (°C)
 A = All available electronic options
 B= Remote mount electronics only

Note

For super duplex models operating above 351 °F (177.2 °C), consult the factory before purchase.

Operating conditions: Process

Process temperature effect

- For mass flow measurement, process temperature effect is defined as the change in sensor flow accuracy specification due to process temperature change away from the calibration temperature. Use the Zero Verification and Smart Meter Verification tools to correct for any process temperature effect.
- For density measurement, process temperature effect is defined as the change in density accuracy specification due to process temperature change away from the calibration temperature.
 - For all models, process temperature effect on density is $\pm 0.000015 \text{ g/cm}^3$ ($\pm 0.015 \text{ kg/m}^3$) per degree difference from calibration temperature.
 - For models ordered with optional temperature calibration, density specification is valid from 0 °F (-17.8 °C) to 60 °F (15.6 °C) and process temperature effect should be considered when operating above or below this range.

Flow process temperature effect for all models

Model	% of maximum mass flow rate per °C
CMF010, CMFS007, CMFS010, CMFS015	± 0.0002
CMF025, CMF050, CMF100, CMFS025, CMFS040, CMFS050, CMFS075, CMFS100, CMFS150	± 0.0001
CMF200, CMF300	± 0.0005
CMF350, CMF400	± 0.0008
CMFHC2, CMFHC3, CMFHC4	± 0.000075

Process pressure effect

Process pressure effect is defined as the change in sensor mass flow and density accuracy specification due to process pressure change away from the calibration pressure. This effect can be corrected by dynamic pressure input or a fixed meter factor. See the calibration sheet for the specific meter pressure compensation coefficient. If no pressure compensation coefficient is provided, use the typical values listed in the table below. For proper setup and configuration, see the *Micro Motion ELITE Coriolis Flow and Density Sensors Installation Manual* at www.emerson.com/flowmeasurement.

Process pressure effect for CMFS models

Model	Mass flow (% of rate)		Density	
	per psi	per bar	g/cm ³ per psi	kg/m ³ per bar
CMFS007, CMFS010, CMFS015	None	None	None	None
CMFS025	None	None	-0.000004	-0.054
CMFS040	-0.0003	-0.005	-0.0000131	-0.187
CMFS050 M	-0.001	-0.015	-0.0000247	-0.358
CMFS050 H/P	None	None	-0.0000034	-0.049
CMFS075	-0.0007	-0.010	-0.0000255	-0.370
CMFS100 M	-0.0015	-0.021	-0.0000276	-0.400
CMFS100 H/P	-0.0003	-0.005	-0.0000132	-0.191

Model	Mass flow (% of rate)		Density	
	per psi	per bar	g/cm ³ per psi	kg/m ³ per bar
CMFS150M	-0.0014	-0.020	-0.000010	-0.145
CMFS150H/P	-0.0004	-0.006	-0.0000062	-0.090

Process pressure effect for CMF and CMFHC models

Model	Mass flow (% of rate)		Density	
	per psi	per bar	g/cm ³ per psi	kg/m ³ per bar
CMF010	None	None	None	None
CMF025	None	None	0.0000040	0.0580
CMF050	None	None	-0.0000020	-0.0290
CMF100	-0.0002	-0.003	-0.0000060	-0.0870
CMF200 M/A/L	-0.00062	-0.009	0.0000010	0.0145
CMF200 H/B	-0.00055	-0.008	0.000001	0.0145
CMF300 M/A/L	-0.0006	-0.009	0.0000002	0.0029
CMF300 H/B	-0.0004	-0.006	0.0000002	0.0029
CMF350	-0.0016	-0.023	-0.000009	-0.1305
CMF400 M/A	-0.0011	-0.016	-0.00001	-0.1450
CMF400 H/B/P	-0.0008	-0.012	-0.00001	-0.1450
CMFHC2	-0.0016	-0.023	-0.0000028	-0.0406
CMFHC3	-0.0010	-0.015	-0.0000025	-0.0363
CMFHC4	-0.0014	-0.020	-0.0000014	-0.0203

Two-phase flow effect

NAMUR NE 132 guidelines state that, “Coriolis meters with a higher agitation frequency react more sensitively to gas bubbles in liquids when compared to devices with a lower agitation frequency.” For operating (agitation) frequency ranges for each model, see [Best practices: installing and selecting meters for two-phase flow](#).

Two-phase flow effects are governed by an increased decoupling ratio or a decreased Velocity of Sound (VoS) in the process fluid due to entrained gas, aeration, or the presence of liquid in gas. Following best practices regarding installation and meter selection can prevent or minimize measurement errors associated with two-phase flow effects.

Tip

For more details regarding the effects of two-phase flow on Coriolis meters, or performance expectations in these applications, see the *Entrained Gas Handling in Micro Motion Coriolis* white paper and any additional resources available at www.emerson.com/flowmeasurement.

Performance influences during two-phase flow conditions

Optimal meter performance during two-phase flow conditions is primarily governed by meter selection, flow regime, and fluid properties. Sample magnitudes of the effect are provided in the white paper referenced previously. The information in the following table provides common forms of influence quantities that can affect measurement performance during two-phase flow conditions.

Two-phase flow performance influence factors

Type of influence	Specific influence on measurement	Recommendation
VoS / fluid compressibility	Over-reading due to interaction between frequency of the acoustic and drive modes	Select a meter that operates in an ULTRA-LOW ⁽¹⁾ or LOW drive frequency range to avoid VoS effects.
Decoupling	Under-reading as a result of bubble or particle movement with respect to the fluid	Increase fluid viscosity, decrease bubble size, or use a meter with lower drive frequency in order to minimize decoupling.
Signal processing noise	Ability to maintain signal accuracy during high noise conditions or rapid process changes	Select advanced electronics that use high-speed mass and density signal processing methods for effective noise rejection.

(1) See [Operating drive mode frequency range for all models](#).

Best practices: installing and selecting meters for two-phase flow

Flow sensor best practices:

- Ensure that the meter is sized correctly to maintain a flow rate greater than 5:1 turndown from nominal.
- Install the meter with the preferred orientation. For orientation based on fluid type, see the *Micro Motion ELITE Coriolis Flow and Density Sensors Installation Manual*
- Select a meter design with the lowest available operating frequency.

Transmitter and electronics best practices:

- Enable multiphase severity alerts to accurately detect when two-phase flow is present.
- Select a meter with a real-time clock and historian capabilities to diagnose process events or upsets.
- Use Advanced Phase Measurement in intermittent high %GVF or %LVF installations where density or volume flow is required.

Operating drive mode frequency range for all models

Reference conditions: water at 14.7 psig (1.014 barg) and 60 °F (16 °C).

- ULTRA-LOW (<100 hz)** Preferred solution for installations with two-phase flow conditions
- LOW (100 - 150 hz)** Preferred solution for installations with two-phase flow conditions
- MID-RANGE (150 - 300 hz)** Suitable in some instances for installations with two-phase flow conditions
- HIGH (> 300 hz)** Not recommended for two-phase flow installations

Nominal line size	Drive mode frequency range and designation			
	ULTRA-LOW (< 100 Hz)	LOW (100 - 150 Hz)	MID-RANGE (150 - 300 Hz)	HIGH (> 300 Hz)
≤ 1 inch (DN25)	CMF010, CMFS010	CMFS007, CMFS015, CMF025, CMFS025, CMFS040, CMF050, CMFS075, CMF100	CMFS050, CMFS100	—
1.5 - 3 inch (DN50 - 80)	CMF200, CMF300	—	CMFS150	—

Nominal line size	Drive mode frequency range and designation			
	ULTRA-LOW (< 100 Hz)	LOW (100 - 150 Hz)	MID-RANGE (150 - 300 Hz)	HIGH (> 300 Hz)
4 - 6 inch (DN100 - 150)	—	CMF350, CMF400	—	—
≥ 6 inch (DN150)	HC2, HC3, HC4	—	—	—

Viscosity range

For installations with 4 in (DN100) or larger meters, and fluid viscosities greater than 500 centistokes (cSt), consult your Micro Motion sales representative or technical support for guidance on optimizing your configuration. This recommendation is not applicable for smaller meters or processes with viscosities less than 500 cSt.

Pressure relief

ELITE sensors are available with a rupture disk installed on the case. Rupture disks vent process fluid from the sensor case in the unlikely event of a flow tube breach. Some users connect a pipeline to the rupture disk to help contain escaping process fluid. For more information about rupture disks, contact customer service.

If the sensor has a rupture disk, keep it installed at all times as it would otherwise be necessary to re-purge the case. If the rupture disk is activated by a tube breach, the seal in the rupture disk will be broken, and the Coriolis meter should be removed from service.

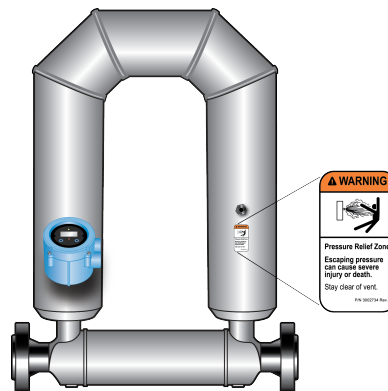

! WARNING

- Orient the sensor so that personnel and equipment will not be exposed to any discharge along the pressure relief path.
- Stay clear of the rupture disk pressure relief area. High-pressure fluid escaping from the sensor can cause severe injury or death.

Important



If using a rupture disk, the housing can no longer assume a secondary containment function.

NOTICE

Removing the purge fitting, blind plug, or rupture disks compromises the Ex-i Safety Certification, the Ex-tc Safety Certification, and the IP-rating of the Coriolis meter. Any modification to the purge fitting, blind plug, or rupture disks must maintain a minimum of IP66/IP67 Ratings.

Hazardous area classifications

Approvals and certifications

Type	Approval or certification (typical)	
CSA and CSA C-US	Ambient temperature: -40 °F (-40.0 °C) to 140 °F (60.0 °C) Class I, Div. 1, Groups C and D Class I, Div. 2, Groups A, B, C, and D. Class II, Div.1, Groups E, F, and G.	
ATEX		II 2G Ex ib IIB/IIC T1-T4/T5/T6 Gb II 2D Ex ib IIIC T(1)°C Db IP66
		II 3G Ex nA IIC T1-T4/T5 Gc II 3D Ex tc IIIC T(1)°C Dc IP66
IECEX	Ex ib IIB/IIC T1-T4/T5/T6 Gb Ex nA IIC T1-T4/T5 Gc	
NEPSI	Ex ib IIB/IIC T1-T6 Gb Ex ibD 21 T450°C-T85°C Ex nA IIC T1-T6 Gc DIP A22 T(1) T1-T6	
Ingress Protection Rating	IP 66/67 for sensors and transmitters	
EMC effects	Complies with EMC directive 2004/108/EC per EN 61326 Industrial	
	Complies with NAMUR NE-21 (22.08.2007)	

Note

For complete details on hazardous area classifications availability by model code, use the *Micro Motion ELITE Coriolis Flow and Density Meters Technical Data Sheet* at www.emerson.com/flowmeasurement.

Marine approval classifications

CMF200M, CMF300M, CMF350M, CMF400M, CMFHC2M, CMFHC3M, and CMFHC4M

Marine approval	Country
Lloyd’s Register ENV1, ENV2, ENV3, ENV5	United Kingdom
Det Norske Veritas- Germanischer Lloyd	Norway-Germany
Bureau Veritas	France
American Bureau of Shipping	USA
Nippon Kaiji Kyokai	Japan

CMFS010H, CMFS015H, CMFS025H, CMFS050H, CMFS100H, and CMFS150H

Marine approval	Country
Lloyd’s Register ENV1, ENV2, ENV3, ENV5	United Kingdom
Det Norske Veritas- Germanischer Lloyd	Norway-Germany

Industry standards

Type	Standard
Weights & Measures for custody transfer applications:	<ul style="list-style-type: none"> ■ MID OIML R117/R137 ■ National Type Evaluation Program (NTEP) ■ Measurement Canada ■ INMETRO Brazil
Hygienic approvals (some models)	<ul style="list-style-type: none"> ■ ASME BPE ■ EHEDG, 3A
Industry standards and commercial approvals	<ul style="list-style-type: none"> ■ NAMUR: NE 132 (burst pressure, sensor flange to flange length), NE131 ■ Pressure Equipment Directive (PED) ■ Canadian Registration Number (CRN) ■ Dual Seal ■ ASME B31.1 power piping code and ASME B31.3 process piping code ■ SIL2 and SIL3 safety certifications ■ All Super Duplex materials comply with NORSOK M-650

Note

- Approvals shown are for ELITE meters configured with a core processor for remote 4-wire connection to a Micro Motion transmitter. Meters with integral electronics may have more restrictive approvals. For details, see the transmitter Product Data Sheet.
- When a meter is ordered with hazardous area approvals, detailed information is shipped along with the product.
- More information about hazardous approvals, including detailed specifications and temperature graphs for all meter configurations is available on the ELITE Series product page at www.emerson.com/flowmeasurement.

Connectivity

ELITE sensors are highly customizable to provide a configuration that is tailor-fit to specific applications.

For help determining which Micro Motion products are right for your application, see the *Micro Motion Technical Overview and Specification Summary* and other resources at www.emerson.com/flowmeasurement.

Communication and diagnostic information

Transmitter interface

- Up to five fully configurable I/O channels, with options for 2-wire, Ethernet, and wireless communication
- Complete suite of mounting options to accommodate installation requirements — integral, remote, wall mount, and DIN rail
- Application software designed specific for your process — batching, concentration, and Advanced Phase Measurement

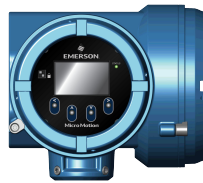

Diagnostic data

- Smart Meter Verification — checks the health and integrity of the meter's tubes, electronics, and calibration without interrupting the process
- Zero verification — quickly diagnoses the meter to determine if re-zeroing is recommended, and if process conditions are stable and optimal for zeroing
- Multiphase detection — proactively identifies multiphase process conditions and severity
- Time-stamped digital audit trails and reports for optimized agency compliance









Communication protocols

Typical I/O connectivity options include:

- 4-20 mA
- HART
- 10k Hz pulse
- Wireless
- Ethernet
- Modbus
- FOUNDATION fieldbus
- PROFIBUS-PA
- PROFIBUS-DP
- Discrete I/O

Transmitter compatibility and primary attributes

For a complete list of all transmitter configurations and options, see the transmitter product data sheets and other resources available at www.emerson.com/flowmeasurement.

Model	Transmitter						
	1500/2500	1700/2700	2400S	3000 series	FMT	4200	5700
							
Flow meters							
CMF	•	•	•	•		•	•
CMFS	•	•	•	•	•	•	•
CMFHC	•	•	•	•			•
Power							
AC		•	•	•			•
DC	•	•	•	•	•		•
Loop powered (2-wire)						•	
Diagnostics							
SMV basic (included)	•	•	•	•		•	•
SMV Pro	•	•	•	•		•	•
Real time clock						•	•
Onboard data historian						•	•
Local operator interface							
2-line display		•	•				
Graphical display				•		•	•
Certifications and approvals							
SIS certified		•				•	•
Custody transfer		•		•			•

Physical specifications

Materials of construction

General corrosion guidelines do not account for cyclical stress, and therefore should not be relied upon when choosing a wetted material for your Micro Motion meter. For material compatibility information, see the *Micro Motion Corrosion Guide*.

Wetted part materials

Model	Stainless steel			Nickel alloy C22	Super duplex	Sensor only weight
	316L	316L 32Ra	304L			
CMFS007	•					10 lb (5 kg)
CMFS010	•	•		•		10 lb (5 kg)
CMFS015	•	•		•		10 lb (5 kg)
CMFS025	•			•		19 lb (9 kg)
CMFS040	•					19 lb (9 kg)
CMFS050	•			•		19 lb (9 kg)
CMFS075	•					30 lb (14 kg)
CMFS100	•			•		30 lb (14 kg)
CMFS150	•			•		30 lb (14 kg)
CMF010	•		•	•		17 lb (8 kg)
CMF025	•		•	•		9 lb (4 kg)
CMF050	•		•	•		14 lb (6 kg)
CMF100	•		•	•		31 lb (14 kg)
CMF200	•		•	•		66 lb (30 kg)
CMF300	•		•	•		180 lb (82 kg)
CMF350	•			•		240 lb (109 kg)
CMF400	•			•		440 lb (200 kg)
CMFHC2	•				•	610 lb (277 kg)
CMFHC3	•				•	770 lb (349 kg)
CHFHC4	•					1,390 lb (630 kg)

Note

- Weight specifications are based upon ASME B16.5 CL 150 flange and do not include electronics.
- Heat jackets and steam kits are also available.

Non-wetted part materials

Component	Enclosure rating	300 series stainless steel	Polyurethane-painted aluminum
Sensor housing	—	•	
Core processor housing	NEMA 4X (IP66/67)	•	•
Junction box	NEMA 4X (IP66)	•	•
Transmitter housing ⁽¹⁾	NEMA 4X (IP66)	•	•

(1) Material of construction and surface finish options vary by model. For available options, see the transmitter Product Data Sheet.

Process connections

Sensor type	Flange types
Stainless steel 316L & cryogenic	<ul style="list-style-type: none"> ■ ASME B16.5 weld neck flange (up to CL600) ■ ASME B16.5 weld neck flange RTJ face (up to CL600) ■ ASME B16.5 weld neck flange raised face (up to CL600) ■ ASME B16.5 wafer style ■ EN 1092-1 weld neck flange Type B1, B2, C, D, E, N (up to PN100) ■ JIS B2220 weld neck raised face (up to 20K) ■ VCO, VCR Swagelok compatible fitting (VCO fittings include the Viton o-ring as a wetted part) ■ Hygienic Tri-Clamp® compatible
Nickel alloy C22	<ul style="list-style-type: none"> ■ ASME B16.5 lap joint flange (up to CL900/1500) ■ EN 1092-1 lap joint flange Type B, D (up to PN160) ■ JIS B2220 lap joint flange (up to 20K)
Nickel alloy C22/316L stainless steel	<ul style="list-style-type: none"> ■ ASME B16.5 weld neck flange (up to CL2500) ■ VCO swagelok compatible fitting ■ EN 1092-1 weld neck flange Type B, D (up to PN250) ■ Hygienic Tri-Clamp compatible
Hygienic	<ul style="list-style-type: none"> ■ Hygienic fittings (Tri-Clamp ASME BPE) ■ Hygienic couplings (DIN11864-1A/2A/3A; DIN11851; ISO 2852/DIN 11850; ISO 2852/ISO 1127; SMS 1145)

Note

For flange compatibility, refer to the Sizing and Selection Tool at www.emerson.com/flowmeasurement.

Dimensions

These dimensional drawings are intended to provide a basic guideline for sizing and planning.

- For Face-to-Face dimensions for ELITE meters with each available process connection, see the *Micro Motion ELITE Coriolis Flow and Density Meters Technical Data Sheet* at www.emerson.com/flowmeasurement.
- For complete and detailed dimensional drawings, see the product drawings link at www.emerson.com/flowmeasurement.

Note

- Accuracy = ± 0.12 in (± 3.0 mm)
- These drawings are representative of a 316 stainless steel model fitted with an ASME B16.5 CL 150 flange, and a 2400 or 5700 transmitter

Example dimensions for CMFS models

Figure 1: CMFS 007, 010, and 015 models

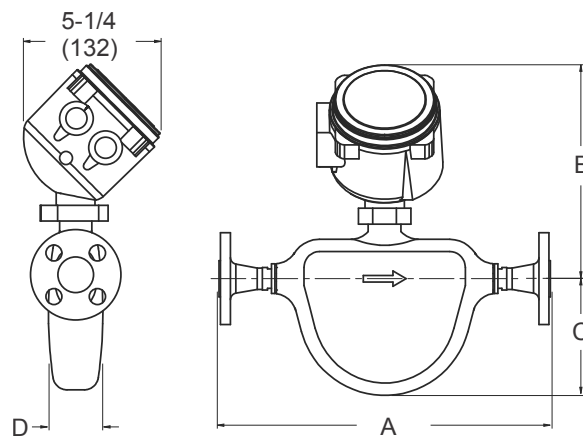
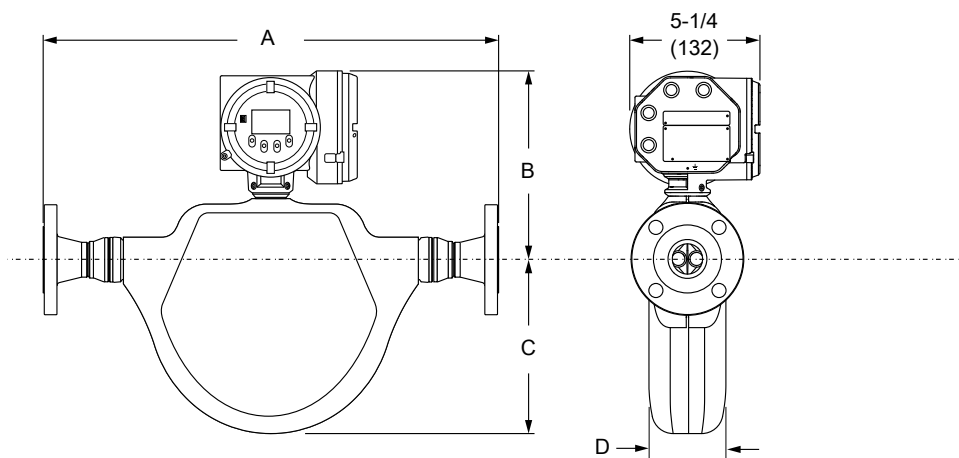

Figure 2: CMFS 025, 040, 050, 075, 100, and 150



Model	Dim. A ASME B16.5 CL150	Dim. B	Dim. C	Dim. D
CMFS007M, CMFS010M, CMFS015M ⁽¹⁾	12.6 in (320 mm)	8.1 in (206 mm)	4.4 in (112 mm)	2.1 in (53 mm)
CMFS025M, CMFS040M, CMFS050M ⁽¹⁾	19.4 in (493 mm)	9.4 in (239 mm)	7.4 in (188 mm)	3.25 in (82.6 mm)
CMFS075M, CMFS100M, CMFS150M CMFS075M, CMFS100M, CMFS150M ⁽²⁾	23.5 in (597 mm)	10.1 in (257 mm)	9.5 in (241 mm)	4 in (102 mm)

- (1) Includes all models with the standard 0.5 in (13 mm) flange.
- (2) Includes all models with the standard 1 in (25 mm) flange.

Example dimensions for the CMF010

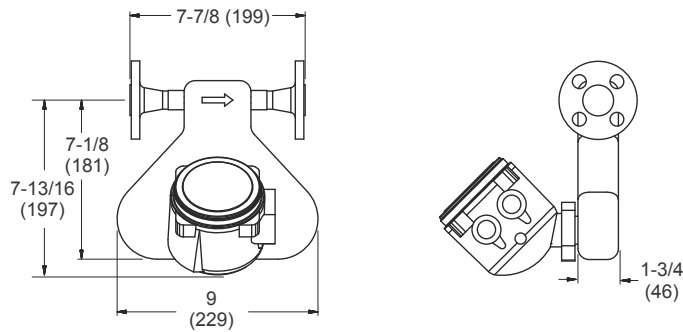

Example dimensions for the CMF025 through CMF100

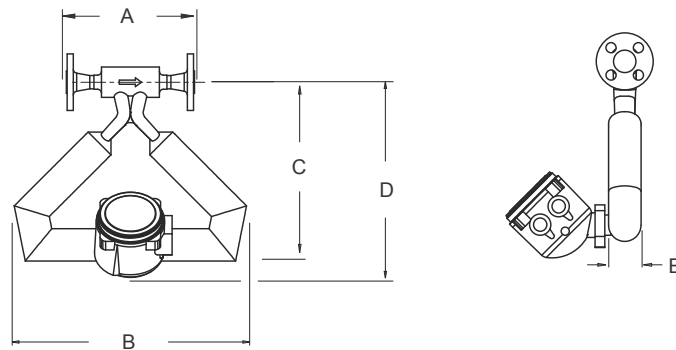

Model	Dim. A ASME B16.5 CL150	Dim. B	Dim. C	Dim. D	Dim. E
CMF010M	7.8 in (198 mm)	9 in (229 mm)	7.1 in (180 mm)	7.8 in (198 mm)	1.8 in (46 mm)
CMF025M	6.75 in (171.4 mm)	10 in (254 mm)	8.25 in (209.5 mm)	9.4 in (239 mm)	1.7 in (43 mm)
CMF050M	7.95 in (201.9 mm)	14.4 in (366 mm)	11.1 in (282 mm)	12 in (305 mm)	2 in (51 mm)
CMF100M	9.25 in (235.0 mm)	21.5 in (546 mm)	16 in (406 mm)	16.1 in (409 mm)	3.5 in (89 mm)

Example dimensions for CMF200 through CMFHC4

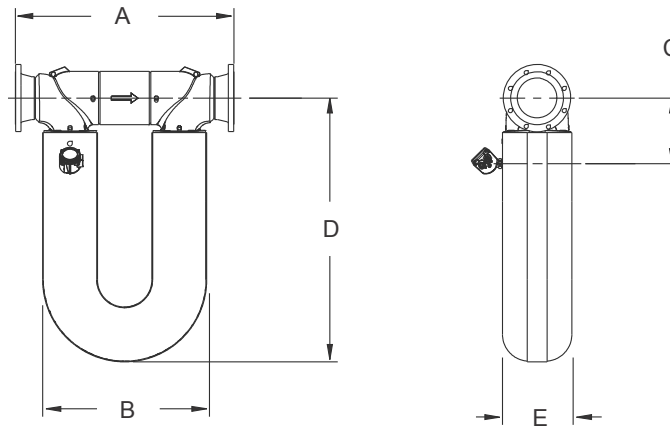

Model	Dim. A ASME B16.5 CL150	Dim. B	Dim. C	Dim. D	Dim. E
CMF200M	22.9 in (582 mm)	19.61 in (498.1 mm)	6.9 in (175 mm)	28.6 in (726 mm)	5.7 in (145 mm)
CMF300M	33.7 in (856 mm)	30.2 in (767 mm)	9.3 in (236 mm)	38.4 in (975 mm)	8.2 in (208 mm)
CMF350M	37.2 in (945 mm)	28.3 in (719 mm)	12.2 in (310 mm)	32.8 in (833 mm)	8.3 in (211 mm)
CMF400M	40.2 in (1,021 mm)	32.8 in (833 mm)	12.4 in (315 mm)	38.1 in (968 mm)	10.8 in (274 mm)
CMFHC2M	42.8 in (1,087 mm)	33 in (838 mm)	12.32 in (312.9 mm)	48.6 in (1,234 mm)	12.8 in (325 mm)
CMFHC3M	43.7 in (1,110 mm)	33 in (838 mm)	13.2 in (335 mm)	53.1 in (1,349 mm)	14 in (356 mm)
CMFHC4M	47.8 in (1,214 mm)	33 in (838 mm)	14.1 in (358 mm)	65.5 in (1,664 mm)	17.8 in (452 mm)

Ordering information

Use this section to select the correct ordering codes for your configuration.

Example model code

The sensor is shipped with a model code stamp so that after purchase, you can verify the ordering codes described in this section.



- A. Sensor and model
- B. Base model
- C. Process connection
- D. Case option
- E. Electronics interface
- F. Conduit connection
- G. Approval
- H. Language
- I. Additional standard approval
- J. Calibration
- K. Measurement application software
- L. Factory options
- M. Certificates, tests, calibrations, and services

Process connections

CMFS010H and CMFS015H (nickel alloy C22)

Code	Description					
323	#4		VCO	N06022	Swagelok compatible fitting	0.25 in (6.4 mm) N10276 NPT female adapter
334	#4		VCO	N06022	Swagelok compatible fitting	
520	0.5 in	CL150	ASME B16.5	F304/F304L	Lap joint flange	N06022 stub
521	0.5 in	CL300	ASME B16.5	F304/F304L	Lap joint flange	N06022 stub
522	15 mm	10K	JIS B 2220	F304/F304L	Lap joint flange	N06022 stub
523	DN15	PN40	DIN 2656	F304/F304L	Lap joint flange	Form C face, N06022 stub
524	DN15	PN40	EN 1092-1	F304/F304L	Lap joint flange	Type B1, N06022 stub

CMFS007M, CMFS010M, and CMFS015M (316L stainless steel)

Code	Description					
172	DN25	PN40	EN 1092-1	F316/F316L	Weld neck flange	Type B1
176	DN15	PN40	EN 1092-1	F316/F316L	Weld neck flange	Type B1
177	DN15	PN100	EN 1092-1	F316/F316L	Weld neck flange	Type B2

Code	Description					
178	DN15	PN100	EN 1092-1	F316/F316L	Weld neck flange	Type D
183	DN25	PN40	EN 1092-1	F316/F316L	Weld neck flange	Type D
300	15 mm	PN40	DIN 2635	F316/F316L	Weld neck flange	Type C
301	15 mm	PN40	DIN 2635	F316/F316L	Weld neck flange	Type N
302	15 mm	PN100	DIN 2635	F316/F316L	Weld neck flange	Type E
303	15 mm	PN100	DIN 2635	F316/F316L	Weld neck flange	Type N
304	15 mm	10K	JIS B 2220	F316/F316L	Weld neck flange	Raised face
305	15 mm	20K	JIS B 2220	F316/F316L	Weld neck flange	Raised face
310	DN15	PN40	EN 1092-1	F316/F316L	Weld neck flange	Type D
313	0.5 in	CL150	ASME B16.5	F316/F316L	Weld neck flange	Raised face
314	0.5 in	CL300	ASME B16.5	F316/F316L	Weld neck flange	Raised face
315	0.5 in	CL600	ASME B16.5	F316/F316L	Weld neck flange	Raised face
319	#8		VCO	316/316L	Swagelok compatible fitting	0.5 in (13 mm) 316 NPT female adapter
321 ⁽¹⁾	0.5 in		Tri-Clamp compatible	316L	Hygienic fitting	
323	#4		VCO	316/316L	Swagelok compatible fitting	0.25 in (6.4 mm) NPT female adapter
324	#4		VCO	316/316L	Swagelok compatible fitting	0.25 in (6.4 mm) tube compression fitting adapter
325	#4		VCO	316/316L	Swagelok compatible fitting	6 mm tube compression fitting adapter
334	#4		VCO	316/316L	Swagelok compatible fitting	
335	#8		VCO	316/316L	Swagelok compatible fitting	
344 ⁽²⁾⁽³⁾	0.75 in		Tri-Clamp compatible	316L	Hygienic fitting	
345 ⁽²⁾⁽³⁾	DN10		ISO 2852/ISO 1127 tube	316L	Hygienic fitting	
346 ⁽²⁾⁽³⁾	DN15		ISO 2852/DIN 11850 tube	316L	Hygienic fitting	

(1) 3A authorized sensor with process connection code 321 and case option code H.

(2) 3A authorized sensor with process connections codes 344, 345 and 346; and case option code H.

(3) Process connections 344, 345, 346 are not available for the CMFS007 sensors.

CMFS010P and CMFS015P (nickel alloy C22/316L stainless steel)

Code	Description					
150	0.5 in	CL900/1500	ASME B16.5	F316/F316L	Weld neck flange	Raised face
191	0.5 in	CL2500	ASME B16.5	F316/F316L	Weld neck flange	Raised face
319	#8		VCO	316/316L	Swagelok compatible fitting	0.5 in (13 mm) 316 NPT female adapter

Code	Description					
323	#4		VCO	316/316L	Swagelok compatible fitting	0.25 in (6.4 mm) NPT female adapter
324	#4		VCO	316/316L	Swagelok compatible fitting	0.25 in (6.4 mm) tube compression fitting adapter
325	#4		VCO	316/316L	Swagelok compatible fitting	6 mm tube compression fitting adapter
334	#4		VCO	316/316L	Swagelok compatible fitting	
335	#8		VCO	316/316L	Swagelok compatible fitting	

CMFS025H and CMFS050H (nickel alloy C22)

Code	Description					
520	0.5 in	CL150	ASME B16.5	F304/F304L	Lap joint flange	N06022 stub
521	0.5 in	CL300	ASME B16.5	F304/F304L	Lap joint flange	N06022 stub
524	DN15	PN40	EN 1092-1	F304/F304L	Lap joint flange	Type B1, N06022 stub

CMFS025M, CMFS040M, and CMFS050M (316L stainless steel)

Code	Description					
172	DN25	PN40	EN 1092-1	F316/F316L	Weld neck flange	Type B1
176	DN15	PN40	EN 1092-1	F316/F316L	Weld neck flange	Type B1
177	DN15	PN100	EN 1092-1	F316/F316L	Weld neck flange	Type B2
178	DN15	PN100	EN 1092-1	F316/F316L	Weld neck flange	Type D
183	DN25	PN40	EN 1092-1	F316/F316L	Weld neck flange	Type D
304	15 mm	10K	JIS B 2220	F316/F316L	Weld neck flange	Raised face
305	15 mm	20K	JIS B 2220	F316/F316L	Weld neck flange	Raised face
310	DN15	PN40	EN 1092-1	F316/F316L	Weld neck flange	Type D
313	0.5 in	CL150	ASME B16.5	F316/F316L	Weld neck flange	Raised face
314	0.5 in	CL300	ASME B16.5	F316/F316L	Weld neck flange	Raised face
315	0.5 in	CL600	ASME B16.5	F316/F316L	Weld neck flange	Raised face
319	#8		VCO	316/316L	Swagelok compatible fitting	0.5 in (13 mm) 316 NPT female adapter
321	0.5 in	Tri-Clamp compatible	ASME BPE	316L	Hygienic fitting	
322	0.75 in	Tri-Clamp compatible	ASME BPE	316L	Hygienic fitting	
335	#8		VCO	316/316L	Swagelok compatible fitting	
336 ⁽¹⁾	#12		VCO	316/316L	Swagelok compatible fitting	
339	1 in	Tri-Clamp compatible	ASME BPE	316L	Hygienic fitting	

(1) Available only on the CMFS050.

CMFS025P and CMFS050P (nickel alloy C22/316L stainless steel)

Code	Description					
150	0.5 in	CL900/1500	ASME B16.5	F316/F316L	Weld neck flange	Raised face
170	DN15	PN100/160	EN 1092-1	F316/F316L	Weld neck flange	Type B2
184	DN15	PN250	EN 1092-1	F316/F316L	Weld neck flange	Type B2
319	#8		VCO	316/316L	Swagelok compatible fitting	0.5 in (13 mm) 316 NPT female adapter
335	#8		VCO	316/316L	Swagelok compatible fitting	
336 ⁽¹⁾	#12		VCO	316/316L	Swagelok compatible fitting	

(1) Available only on the CMFS050.

CMFS075M, CMFS100M, and CMFS150M (316L stainless steel)

Code	Description					
179	DN25	PN40	EN 1092-1	F316/F316L	Weld neck flange	Type B1
180	DN25	PN100	EN 1092-1	F316/F316L	Weld neck flange	Type B2
181	DN25	PN100	EN 1092-1	F316/F316L	Weld neck flange	Type D
311	DN25	PN40	EN 1092-1	F316/F316L	Weld neck flange	Type D
316	DN50	PN40	EN 1092-1	F316/F316L	Weld neck flange	Type D
317	25 mm	10K	JIS B 2220	F316/F316L	Weld neck flange	Raised face
318	25 mm	20K	JIS B 2220	F316/F316L	Weld neck flange	Raised face
322 ⁽¹⁾	0.75 in	Tri-Clamp compatible	ASME BPE	316L	Hygienic fitting	
328	1 in	CL150	ASME B16.5	F316/F316L	Weld neck flange	Raised face
329	1 in	CL300	ASME B16.5	F316/F316L	Weld neck flange	Raised face
330	1 in	CL600	ASME B16.5	F316/F316L	Weld neck flange	Raised face
331	1.5 in	CL600	ASME B16.5	F316/F316L	Weld neck flange	Raised face
336 ⁽²⁾	#12		VCO	316/316L	Swagelok compatible fitting	
339 ⁽¹⁾	1 in		Tri-Clamp compatible	316L	Hygienic fitting	
341	1.5 in	CL150	ASME B16.5	F316/F316L	Weld neck flange	Raised face
342	1.5 in	CL300	ASME B16.5	F316/F316L	Weld neck flange	Raised face
351	1.5 in	Tri-Clamp compatible	ASME BPE	316L	Hygienic fitting	
352	2 in	Tri-Clamp compatible	ASME BPE	316L	Hygienic fitting	
363	DN40	PN100	EN 1092-1	F316/F316L	Weld neck flange	Type B2
365	DN50	PN100	EN 1092-1	F316/F316L	Weld neck flange	Type B2
366	DN40	PN100	EN 1092-1	F316/F316L	Weld neck flange	Type D
368	DN40	PN40	EN 1092-1	F316/F316L	Weld neck flange	Type B1

Code	Description					
369	DN50	PN40	EN 1092-1	F316/F316L	Weld neck flange	Type B1
385	40 mm	10K	JIS B 2220	F316/F316L	Weld neck flange	Raised face
387	40 mm	20K	JIS B 2220	F316/F316L	Weld neck flange	Raised face
418	2 in	CL150	ASME B16.5	F316/F316L	Weld neck flange	Raised face
419	2 in	CL300	ASME B16.5	F316/F316L	Weld neck flange	Raised face
420	2 in	CL600	ASME B16.5	F316/F316L	Weld neck flange	Raised face

(1) Not available on the CMFS150.

(2) Available only on the CMFS075.

CMFS100H and CMFS150H (nickel alloy C22)

Code	Description					
530 ⁽¹⁾	1 in	CL150	ASME B16.5	F304/F304L	Lap joint flange	N06022 stub
531 ⁽¹⁾	1 in	CL300	ASME B16.5	F304/F304L	Lap joint flange	N06022 stub
534 ⁽¹⁾	DN25	PN40	EN 1092-1	F304/F304L	Lap joint flange	Type B1, N06022 stub
540	1.5 in	CL150	ASME B16.5	F304/F304L	Lap joint flange	N06022 stub
541	1.5 in	CL300	ASME B16.5	F304/F304L	Lap joint flange	N06022 stub
544	2 in	CL150	ASME B16.5	F304/F304L	Lap joint flange	N06022 stub
545	2 in	CL300	ASME B16.5	F304/F304L	Lap joint flange	N06022 stub
549	DN50	PN40	EN 1092-1	F304/F304L	Lap joint flange	Type B1, N06022 stub

(1) Available only on the CMFS100H.

CMFS100P and CMFS150P (high pressure)

Code	Description					
180	DN25	PN100	EN 1092-1	F316/F316L	Weld neck flange	Type B2
185	DN25	PN250	EN 1092-1	F316/F316L	Weld neck flange	Type B2
362	DN40	PN160	EN 1092-1	F316/F316L	Weld neck flange	Type B2
364	DN40	PN250	EN 1092-1	F316/F316L	Weld neck flange	Type B2
370	DN50	PN160	EN 1092-1	F316/F316L	Weld neck flange	Type B2
483	DN50	PN250	EN 1092-1	F316/F316L	Weld neck flange	Type B2

CMF010H, CMF025H, and CMF050H (nickel alloy C22)

Code	Description					
323 ⁽¹⁾	#4		VCO	N06022	Swagelok compatible fitting	0.25 in (6.4 mm) N10276 NPT female adapter
334 ⁽¹⁾	#4		VCO	N06022	Swagelok compatible fitting	
520	0.5 in	CL150	ASME B16.5	F304/F304L	Lap joint flange	N06022 stub
521	0.5 in	CL300	ASME B16.5	F304/F304L	Lap joint flange	N06022 stub
522	15 mm	10K	JIS B 2220	F304/F304L	Lap joint flange	N06022 stub

Code	Description					
523	DN15	PN40	DIN 2656	F304/F304L	Lap joint flange	Form C face, N06022 stub
524	DN15	PN40	EN 1092-1	F304/F304L	Lap joint flange	Type B1, N06022 stub

(1) Available only on the CMF010H.

CMF010L, CMF025L, and CMF050L (304L stainless steel)

Code	Description					
413	0.5 in	CL150	ASME B16.5	F304/F304L	Weld neck flange	Raised face
414	0.5 in	CL300	ASME B16.5	F304/F304L	Weld neck flange	Raised face
421	DN15	PN40	EN 1092-1	F304/F304L	Weld neck flange	Type B1
423	DN15	PN40	DIN 2526	F304/F304L	Weld neck flange	Form C face

CMF010M (316L stainless steel)

Code	Description					
172	DN25	PN40	EN 1092-1	F316/F316L	Weld neck flange	Type B1
176	DN15	PN40	EN 1092-1	F316/F316L	Weld neck flange	Type B1
177	DN15	PN100	EN 1092-1	F316/F316L	Weld neck flange	Type B2
178	DN15	PN100	EN 1092-1	F316/F316L	Weld neck flange	Type D
183	DN25	PN40	EN 1092-1	F316/F316L	Weld neck flange	Type D
300	DN15	PN40	DIN 2635	F316/F316L	Weld neck flange	Form C face
302	DN15	PN100	DIN 2637	F316/F316L	Weld neck flange	Form E face
304	15 mm	10K	JIS B 2220	F316/F316L	Weld neck flange	Raised face
305	15 mm	20K	JIS B 2220	F316/F316L	Weld neck flange	Raised face
310	DN15	PN40	EN 1092-1	F316/F316L	Weld neck flange	Type D
313	0.5 in	CL150	ASME B16.5	F316/F316L	Weld neck flange	Raised face
314	0.5 in	CL300	ASME B16.5	F316/F316L	Weld neck flange	Raised face
315	0.5 in	CL600	ASME B16.5	F316/F316L	Weld neck flange	Raised face
321	0.5 in		Tri-Clamp compatible	316L	Hygienic fitting	
323	#4		VCO	316/316L	Swagelok compatible fitting	0.25 in (6.4 mm) NPT female adapter
324	#4		VCO	316/316L	Swagelok compatible fitting	0.25 in (6.4 mm) tube compression fitting adapter
325	#4		VCO	316/316L	Swagelok compatible fitting	6 mm tube compression fitting adapter
334	#4		VCO	316/316L	Swagelok compatible fitting	

CMF010P (high pressure)

Code	Description					
323	#4		VCO	316/316L	Swagelok compatible fitting	0.25 in (6.4 mm) NPT female adapter
324	#4		VCO	316/316L	Swagelok compatible fitting	0.25 in (6.4 mm) tube compression fitting adapter
325	#4		VCO	316/316L	Swagelok compatible fitting	6 mm tube compression fitting adapter
334	#4		VCO	316/316L	Swagelok compatible fitting	

CMF025M (316L stainless steel)

Code	Description					
172	DN25	PN40	EN 1092-1	F316/F316L	Weld neck flange	Type B1
176	DN15	PN40	EN 1092-1	F316/F316L	Weld neck flange	Type B1
177	DN15	PN100	EN 1092-1	F316/F316L	Weld neck flange	Type B2
178	DN15	PN100	EN 1092-1	F316/F316L	Weld neck flange	Type D
183	DN25	PN40	EN 1092-1	F316/F316L	Weld neck flange	Type D
300	DN15	PN40	DIN 2635	F316/F316L	Weld neck flange	Form C face
301	DN15	PN40	DIN 2635	F316/F316L	Weld neck flange	Form N grooved face
302	DN15	PN100	DIN 2637	F316/F316L	Weld neck flange	Form E face
303	DN15	PN100	DIN 2637	F316/F316L	Weld neck flange	Form N grooved face
304	15 mm	10K	JIS B 2220	F316/F316L	Weld neck flange	Raised face
305	15 mm	20K	JIS B 2220	F316/F316L	Weld neck flange	Raised face
310	DN15	PN40	EN 1092-1	F316/F316L	Weld neck flange	Type D
313	0.5 in	CL150	ASME B16.5	F316/F316L	Weld neck flange	Raised face
314	0.5 in	CL300	ASME B16.5	F316/F316L	Weld neck flange	Raised face
315	0.5 in	CL600	ASME B16.5	F316/F316L	Weld neck flange	Raised face
319	#8		VCO	316/316L	Swagelok compatible fitting	0.5 in (13 mm) NPT female adapter
321	0.5 in		Tri-Clamp compatible	316L	Hygienic fitting	
335	#8		VCO	316/316L	Swagelok compatible fitting	

CMF050M (316L stainless steel)

Code	Description					
172	DN25	PN40	EN 1092-1	F316/F316L	Weld neck flange	Type B1
176	DN15	PN40	EN 1092-1	F316/F316L	Weld neck flange	Type B1
177	DN15	PN100	EN 1092-1	F316/F316L	Weld neck flange	Type B2
178	DN15	PN100	EN 1092-1	F316/F316L	Weld neck flange	Type D

Code	Description					
183	DN25	PN40	EN 1092-1	F316/F316L	Weld neck flange	Type D
300	DN15	PN40	DIN 2635	F316/F316L	Weld neck flange	Form C face
301	DN15	PN40	DIN 2635	F316/F316L	Weld neck flange	Form N grooved face
302	DN15	PN100	DIN 2637	F316/F316L	Weld neck flange	Form E face
303	DN15	PN100	DIN 2637	F316/F316L	Weld neck flange	Form N grooved face
304	15 mm	10K	JIS B 2220	F316/F316L	Weld neck flange	Raised face
305	15 mm	20K	JIS B 2220	F316/F316L	Weld neck flange	Raised face
310	DN15	PN40	EN 1092-1	F316/F316L	Weld neck flange	Type D
313	0.5 in	CL150	ASME B16.5	F316/F316L	Weld neck flange	Raised face
314	0.5 in	CL300	ASME B16.5	F316/F316L	Weld neck flange	Raised face
315	0.5 in	CL600	ASME B16.5	F316/F316L	Weld neck flange	Raised face
319	#8		VCO	316/316L	Swagelok compatible fitting	0.5 in (13 mm) NPT female adapter
320	#12		VCO	316/316L	Swagelok compatible fitting	0.75 in (19.0 mm) NPT female adapter
322	0.75 in		Tri-Clamp compatible	316L	Hygienic fitting	
336	#12		VCO	316/316L	Swagelok compatible fitting	

CMF100H (nickel alloy C22)

Code	Description					
530	1 in	CL150	ASME B16.5	F304/F304L	Lap joint flange	N06022 stub
531	1 in	CL300	ASME B16.5	F304/F304L	Lap joint flange	N06022 stub
532	25 mm	10K	JIS B 2220	F304/F304L	Lap joint flange	N06022 stub
533	DN25	PN40	DIN 2656	F304/F304L	Lap joint flange	Form C face, N06022 stub
534	DN25	PN40	EN 1092-1	F304/F304L	Lap joint flange	Type B1, N06022 stub

CMF100L (304L stainless steel)

Code	Description					
415	1 in	CL150	ASME B16.5	F304/F304L	Weld neck flange	Raised face
416	1 in	CL300	ASME B16.5	F304/F304L	Weld neck flange	Raised face
422	DN25	PN40	EN 1092-1	F304/F304L	Weld neck flange	Type B1
424	DN25	PN40	DIN 2526	F304/F304L	Weld neck flange	Form C face

CMF100M (316L stainless steel)

Code	Description					
179	DN25	PN40	EN 1092-1	F316/F316L	Weld neck flange	Type B1
180	DN25	PN100	EN 1092-1	F316/F316L	Weld neck flange	Type B2
181	DN25	PN100	EN 1092-1	F316/F316L	Weld neck flange	Type D
306	DN25	PN40	DIN 2635	F316/F316L	Weld neck flange	Form C face
307	DN25	PN40	DIN 2635	F316/F316L	Weld neck flange	Form N grooved face
308	DN25	PN100	DIN 2637	F316/F316L	Weld neck flange	Form E face
309	DN25	PN100	DIN 2637	F316/F316L	Weld neck flange	Form N grooved face
311	DN25	PN40	EN 1092-1	F316/F316L	Weld neck flange	Type D
317	25 mm	10K	JIS B 2220	F316/F316L	Weld neck flange	Raised face
318	25 mm	20K	JIS B 2220	F316/F316L	Weld neck flange	Raised face
328	1 in	CL150	ASME B16.5	F316/F316L	Weld neck flange	Raised face
329	1 in	CL300	ASME B16.5	F316/F316L	Weld neck flange	Raised face
330	1 in	CL600	ASME B16.5	F316/F316L	Weld neck flange	Raised face
331	1.5 in	CL600	ASME B16.5	F316/F316L	Weld neck flange	Raised face
339	1 in		Tri-Clamp compatible	316L	Hygienic fitting	

CMF200H and CMF200B (standard or high temperature nickel alloy C22)

Code	Description					
537	1.5 in	CL600	ASME B16.5	F304/F304L	Lap joint flange	N06022 stub
540	1.5 in	CL150	ASME B16.5	F304/F304L	Lap joint flange	N06022 stub
541	1.5 in	CL300	ASME B16.5	F304/F304L	Lap joint flange	N06022 stub
542	40 mm	10K	JIS B 2220	F304/F304L	Lap joint flange	N06022 stub
543	DN40	PN40	DIN 2656	F304/F304L	Lap joint flange	Form C face, N06022 stub
544	2 in	CL150	ASME B16.5	F304/F304L	Lap joint flange	N06022 stub
545	2 in	CL300	ASME B16.5	F304/F304L	Lap joint flange	N06022 stub
546	50 mm	10K	JIS B 2220	F304/F304L	Lap joint flange	N06022 stub
547	DN50	PN40	DIN 2656	F304/F304L	Lap joint flange	Form C face, N06022 stub
548	DN40	PN40	EN 1092-1	F304/F304L	Lap joint flange	Type B1, N06022 stub
549	DN50	PN40	EN 1092-1	F304/F304L	Lap joint flange	Type B1, N06022 stub

CMF200L (304L stainless steel)

Code	Description					
441	1.5 in	CL150	ASME B16.5	F304/F304L	Weld neck flange	Raised face
442	1.5 in	CL300	ASME B16.5	F304/F304L	Weld neck flange	Raised face
457	DN40	PN40	EN 1092-1	F304/F304L	Weld neck flange	Type B1
458	DN50	PN40	EN 1092-1	F304/F304L	Weld neck flange	Type B1
481	DN40	PN40	DIN 2526	F304/F304L	Weld neck flange	Form C face
482	DN50	PN40	DIN 2526	F304/F304L	Weld neck flange	Form C face
518	2 in	CL150	ASME B16.5	F304/F304L	Weld neck flange	Raised face
519	2 in	CL300	ASME B16.5	F304/F304L	Weld neck flange	Raised face

CMF200M and CMF200A (standard or high temperature 316L stainless steel)

Code	Description					
312	DN40	PN40	EN 1092-1	F316/F316L	Weld neck flange	Type D
316	DN50	PN40	EN 1092-1	F316/F316L	Weld neck flange	Type D
341	1.5 in	CL150	ASME B16.5	F316/F316L	Weld neck flange	Raised face
342	1.5 in	CL300	ASME B16.5	F316/F316L	Weld neck flange	Raised face
343	1.5 in	CL600	ASME B16.5	F316/F316L	Weld neck flange	Raised face
351 ⁽¹⁾	1.5 in		Tri-Clamp compatible	316L	Hygienic fitting	
352 ⁽²⁾	2 in		Tri-Clamp compatible	316L	Hygienic fitting	
363	DN40	PN100	EN 1092-1	F316/F316L	Weld neck flange	Type B2
365	DN50	PN100	EN 1092-1	F316/F316L	Weld neck flange	Type B2
366	DN40	PN100	EN 1092-1	F316/F316L	Weld neck flange	Type D
367	DN50	PN100	EN 1092-1	F316/F316L	Weld neck flange	Type D
368	DN40	PN40	EN 1092-1	F316/F316L	Weld neck flange	Type B1
369	DN50	PN40	EN 1092-1	F316/F316L	Weld neck flange	Type B1
377	DN40	PN100	DIN 2637	F316/F316L	Weld neck flange	Form E face
378	DN50	PN100	DIN 2637	F316/F316L	Weld neck flange	Form E face
379	DN40	PN100	DIN 2637	F316/F316L	Weld neck flange	Form N grooved face
380	DN50	PN100	DIN 2637	F316/F316L	Weld neck flange	Form N grooved face
381	DN40	PN40	DIN 2635	F316/F316L	Weld neck flange	Form C face
382	DN50	PN40	DIN 2635	F316/F316L	Weld neck flange	Form C face
383	DN40	PN40	DIN 2635	F316/F316L	Weld neck flange	Form N grooved face
384	DN50	PN40	DIN 2635	F316/F316L	Weld neck flange	Form N grooved face
385	40 mm	10K	JIS B 2220	F316/F316L	Weld neck flange	Raised face
386	50 mm	10K	JIS B 2220	F316/F316L	Weld neck flange	Raised face

Code	Description					
387	40 mm	20K	JIS B 2220	F316/F316L	Weld neck flange	Raised face
388	50 mm	20K	JIS B 2220	F316/F316L	Weld neck flange	Raised face
418	2 in	CL150	ASME B16.5	F316/F316L	Weld neck flange	Raised face
419	2 in	CL300	ASME B16.5	F316/F316L	Weld neck flange	Raised face
420	2 in	CL600	ASME B16.5	F316/F316L	Weld neck flange	Raised face

(1) Fitting code 351 is not available with high temperature models (base model variation code A).

(2) Fitting code 352 is not available with high temperature models (base model variation code A).

CMF300H and CMF300B (standard or high temperature nickel alloy C22)

Code	Description					
539	3 in	CL600	ASME B16.5	F304/F304L	Lap joint flange	N06022 stub
550	3 in	CL150	ASME B16.5	F304/F304L	Lap joint flange	N06022 stub
551	3 in	CL300	ASME B16.5	F304/F304L	Lap joint flange	N06022 stub
552	80 mm	10K	JIS B 2220	F304/F304L	Lap joint flange	N06022 stub
553	DN80	PN40	DIN 2656	F304/F304L	Lap joint flange	Form C face, N06022 stub
554	DN80	PN40	EN 1092-1	F304/F304L	Lap joint flange	Type B1, N06022 stub

CMF300L (304L stainless steel)

Code	Description					
455	3 in	CL150	ASME B16.5	F304/F304L	Weld neck flange	Raised face
456	3 in	CL300	ASME B16.5	F304/F304L	Weld neck flange	Raised face
459	DN80	PN40	EN 1092-1	F304/F304L	Weld neck flange	Type B1
491	DN80	PN40	DIN 2526	F304/F304L	Weld neck flange	Form C face

CMF300M and CMF300A (standard or high temperature 316L stainless steel)

Code	Description					
326	DN80	PN40	EN 1092-1	F316/F316L	Weld neck flange	Type D
333	DN100	PN40	EN 1092-1	F316/F316L	Weld neck flange	Type D
355	3 in	CL150	ASME B16.5	F316/F316L	Weld neck flange	Raised face
356	3 in	CL300	ASME B16.5	F316/F316L	Weld neck flange	Raised face
357	3 in	CL600	ASME B16.5	F316/F316L	Weld neck flange	Raised face
358	3 in	CL900	ASME B16.5	F316/F316L	Weld neck flange	Raised face
359	DN100	PN100	EN 1092-1	F316/F316L	Weld neck flange	Type D
361 ⁽¹⁾	3 in		Tri-Clamp compatible	316L	Hygienic fitting	
371	DN80	PN40	EN 1092-1	F316/F316L	Weld neck flange	Type B1
372	DN100	PN40	EN 1092-1	F316/F316L	Weld neck flange	Type B1

Code	Description					
373	DN80	PN100	EN 1092-1	F316/F316L	Weld neck flange	Type B2
374	DN100	PN100	EN 1092-1	F316/F316L	Weld neck flange	Type B2
375	DN80	PN100	EN 1092-1	F316/F316L	Weld neck flange	Type D
391	DN80	PN40	DIN 2635	F316/F316L	Weld neck flange	Form C face
392	DN100	PN40	DIN 2635	F316/F316L	Weld neck flange	Form C face
393	DN80	PN40	DIN 2635	F316/F316L	Weld neck flange	Form N grooved face
394	DN100	PN40	DIN 2635	F316/F316L	Weld neck flange	Form N grooved face
395	DN80	PN100	DIN 2637	F316/F316L	Weld neck flange	Form E face
396	DN100	PN100	DIN 2637	F316/F316L	Weld neck flange	Form E face
397	DN80	PN100	DIN 2637	F316/F316L	Weld neck flange	Form N grooved face
398	DN100	PN100	DIN 2637	F316/F316L	Weld neck flange	Form N grooved face
400	80 mm	10K	JIS B 2220	F316/F316L	Weld neck flange	Raised face
401	100 mm	10K	JIS B 2220	F316/F316L	Weld neck flange	Raised face
402	80 mm	20K	JIS B 2220	F316/F316L	Weld neck flange	Raised face
425	4 in	CL150	ASME B16.5	F316/F316L	Weld neck flange	Raised face
426	4 in	CL300	ASME B16.5	F316/F316L	Weld neck flange	Raised face
427	4 in	CL600	ASME B16.5	F316/F316L	Weld neck flange	Raised face
428	4 in	CL900	ASME B16.5	F316/F316L	Weld neck flange	Raised face

(1) Available only with the CMF300M.

CMF350M and CMF350A (standard or high temperature 316L stainless steel)

Code	Description					
435	4 in	CL150	ASME B16.5	F316/F316L	Weld neck flange	Raised face
436	4 in	CL300	ASME B16.5	F316/F316L	Weld neck flange	Raised face
437	4 in	CL600	ASME B16.5	F316/F316L	Weld neck flange	Raised face
443 ⁽¹⁾	DN100	PN40	EN 1092-1	F316/F316L	Weld neck flange	Type B1
445 ⁽¹⁾	DN100	PN100	EN 1092-1	F316/F316L	Weld neck flange	Type B2
447 ⁽¹⁾	DN100	PN100	EN 1092-1	F316/F316L	Weld neck flange	Type D
470	100 mm	10K	JIS B 2220	F316/F316L	Weld neck flange	Raised face
472	100 mm	20K	JIS B 2220	F316/F316L	Weld neck flange	Raised face
480	DN100	PN40	EN 1092-1	F316/F316L	Weld neck flange	Type D

(1) Not available with approval code T or J.

CMF400H and CMF400B (standard or high temperature nickel alloy C22)

Code	Description					
906	DN100	PN40	EN 1092-1	N06022	Weld neck flange	Type B1
908	DN100	PN100	EN 1092-1	N06022	Lap joint flange	Type B2

Code	Description					
910	DN100	PN160	EN 1092-1	N06022	Lap joint flange	Type B2
911	4 in	CL150	ASME B16.5	N06022	Weld neck flange	Raised face
912	4 in	CL300	ASME B16.5	N06022	Weld neck flange	Raised face
913	4 in	CL600	ASME B16.5	N06022	Weld neck flange	Raised face
914	4 in	CL900	ASME B16.5	N06022	Weld neck flange	Raised face

CMF400M and CMF400A (standard or high temperature 316L stainless steel)

Code	Description					
435	4 in	CL150	ASME B16.5	F316/F316L	Weld neck flange	Raised face
436	4 in	CL300	ASME B16.5	F316/F316L	Weld neck flange	Raised face
437	4 in	CL600	ASME B16.5	F316/F316L	Weld neck flange	Raised face
438	4 in	CL900	ASME B16.5	F316/F316L	Weld neck flange	Raised face
439	4 in	CL1500	ASME B16.5	F316/F316L	Weld neck flange	Raised face
443 ⁽¹⁾	DN100	PN40	EN 1092-1	F316/F316L	Weld neck flange	Type B1
444 ⁽¹⁾	DN150	PN40	EN 1092-1	F316/F316L	Weld neck flange	Type B1
445 ⁽¹⁾	DN100	PN100	EN 1092-1	F316/F316L	Weld neck flange	Type B2
446 ⁽¹⁾	DN150	PN100	EN 1092-1	F316/F316L	Weld neck flange	Type B2
447 ⁽¹⁾	DN100	PN100	EN 1092-1	F316/F316L	Weld neck flange	Type D
448 ⁽¹⁾	DN150	PN100	EN 1092-1	F316/F316L	Weld neck flange	Type D
451	6 in	CL150	ASME B16.5	F316/F316L	Weld neck flange	Raised face
452	6 in	CL300	ASME B16.5	F316/F316L	Weld neck flange	Raised face
453	6 in	CL600	ASME B16.5	F316/F316L	Weld neck flange	Raised face
460	DN100	PN40	DIN 2635	F316/F316L	Weld neck flange	Form C face
461	DN150	PN40	DIN 2635	F316/F316L	Weld neck flange	Form C face
462	DN100	PN40	DIN 2635	F316/F316L	Weld neck flange	Form N grooved face
463	DN150	PN40	DIN 2635	F316/F316L	Weld neck flange	Form N grooved face
464	DN100	PN100	DIN 2637	F316/F316L	Weld neck flange	Form E face
465	DN150	PN100	DIN 2637	F316/F316L	Weld neck flange	Form E face
466	DN100	PN100	DIN 2637	F316/F316L	Weld neck flange	Form N grooved face
467	DN150	PN100	DIN 2637	F316/F316L	Weld neck flange	Form N grooved face
470	100 mm	10K	JIS B 2220	F316/F316L	Weld neck flange	Raised face
471	150 mm	10K	JIS B 2220	F316/F316L	Weld neck flange	Raised face
472	100 mm	20K	JIS B 2220	F316/F316L	Weld neck flange	Raised face
473 ⁽²⁾	150 mm	20K	JIS B 2220	F316/F316L	Weld neck flange	Raised face

Code	Description					
478	DN150	PN40	EN 1092-1	F316/F316L	Weld neck flange	Type D
480	DN100	PN40	EN 1092-1	F316/F316L	Weld neck flange	Type D

(1) Not available with approval code T or J.

(2) Applies to the CMF400A only.

CMF350P (high pressure)

Code	Description					
437	4 in	CL600	ASME B16.5	F316/F316L	Weld neck flange	Raised face
438	4 in	CL900	ASME B16.5	F316/F316L	Weld neck flange	Raised face
445	DN100	PN100	EN 1092-1	F316/F316L	Weld neck flange	Type B2
447	DN100	PN100	EN 1092-1	F316/F316L	Weld neck flange	Type D
468	DN100	PN160	EN 1092-1	F316/F316L	Weld neck flange	Type B2
472	100 mm	20K	JIS B 2220	F316/F316L	Weld neck flange	Raised face
473	150 mm	20K	JIS B 2220	F316/F316L	Weld neck flange	Raised face
562	4 in	CL600	ASME B16.5	A105 Carbon Steel	Lap joint flange	316/316L stub
563	4 in	CL900	ASME B16.5	A105 Carbon Steel	Lap joint flange	316/316L stub

CMF400P (high pressure)

Code	Description					
437	4 in	CL600	ASME B16.5	F316/F316L	Weld neck flange	Raised face
438 ⁽¹⁾	4 in	CL900	ASME B16.5	F316/F316L	Weld neck flange	Raised face
439	4 in	CL1500	ASME B16.5	F316/F316L	Weld neck flange	Raised face
445 ⁽¹⁾	DN100	PN100	EN 1092-1	F316/F316L	Weld neck flange	Type B2
446 ⁽¹⁾	DN150	PN100	EN 1092-1	F316/F316L	Weld neck flange	Type B2
447 ⁽¹⁾	DN100	PN100	EN 1092-1	F316/F316L	Weld neck flange	Type D
448 ⁽¹⁾	DN150	PN100	EN 1092-1	F316/F316L	Weld neck flange	Type D
453	6 in	CL600	ASME B16.5	F316/F316L	Weld neck flange	Raised face
468	DN100	PN160	EN 1092-1	F316/F316L	Weld neck flange	Type B2
472	100 mm	20K	JIS B 2220	F316/F316L	Weld neck flange	Raised face
473	150 mm	20K	JIS B 2220	F316/F316L	Weld neck flange	Raised face
562	4 in	CL600	ASME B16.5	A105 Carbon Steel	Lap joint flange	316/316L stub
563	4 in	CL900	ASME B16.5	A105 Carbon Steel	Lap joint flange	316/316L stub

(1) Not available with approval code T or J.

CMFHC2M and CMFHC2A (standard or high temperature 316L stainless steel)

Code	Description					
451	6 in	CL150	ASME B16.5	F316/F316L	Weld neck flange	Raised face
452	6 in	CL300	ASME B16.5	F316/F316L	Weld neck flange	Raised face
453	6 in	CL600	ASME B16.5	F316/F316L	Weld neck flange	Raised face
801	DN200	PN40	EN 1092-1	F316/F316L	Weld neck flange	Type B1
802	DN200	PN100	EN 1092-1	F316/F316L	Weld neck flange	Type B2
803	DN200	PN160	EN 1092-1	F316/F316L	Weld neck flange	Type B2
810	8 in	CL150	ASME B16.5	F316/F316L	Weld neck flange	Raised face
811	8 in	CL300	ASME B16.5	F316/F316L	Weld neck flange	Raised face
818	8 in	CL600	ASME B16.5	F316/F316L	Weld neck flange	Raised face
819	8 in	CL900	ASME B16.5	F316/F316L	Weld neck flange	Raised face
821	6 in	CL900	ASME B16.5	F316/F316L	Weld neck flange	Raised face
822	DN150	PN40	EN 1092-1	F316/F316L	Weld neck flange	Type B1
823	DN150	PN100	EN 1092-1	F316/F316L	Weld neck flange	Type B2
824	DN150	PN160	EN 1092-1	F316/F316L	Weld neck flange	Type B2

CMFHC2Y (super duplex UNS S32750)

Code	Description					
956	DN200	PN40	EN 1092-1	Super duplex	Weld neck flange	Type B1
957	DN200	PN100	EN 1092-1	Super duplex	Weld neck flange	Type B2
958	DN200	PN160	EN 1092-1	Super duplex	Weld neck flange	Type B2
959	DN150	PN40	EN 1092-1	Super duplex	Weld neck flange	Type B1
960	DN150	PN100	EN 1092-1	Super duplex	Weld neck flange	Type B2
961	DN150	PN160	EN 1092-1	Super duplex	Weld neck flange	Type B2
962	8 in	CL150	ASME B16.5	Super duplex	Weld neck flange	Raised face
963	8 in	CL300	ASME B16.5	Super duplex	Weld neck flange	Raised face
964	8 in	CL600	ASME B16.5	Super duplex	Weld neck flange	Raised face
965	8 in	CL900	ASME B16.5	Super duplex	Weld neck flange	Raised face
966	6 in	CL150	ASME B16.5	Super duplex	Weld neck flange	Raised face
967	6 in	CL300	ASME B16.5	Super duplex	Weld neck flange	Raised face
968	6 in	CL600	ASME B16.5	Super duplex	Weld neck flange	Raised face
969	6 in	CL900	ASME B16.5	Super duplex	Weld neck flange	Raised face

CMFHC3M and CMFHC3A (standard or high temperature 316L stainless steel)

Code	Description					
801	DN200	PN40	EN 1092-1	F316/F316L	Weld neck flange	Type B1
802	DN200	PN100	EN 1092-1	F316/F316L	Weld neck flange	Type B2
803	DN200	PN160	EN 1092-1	F316/F316L	Weld neck flange	Type B2
804	DN250	PN40	EN 1092-1	F316/F316L	Weld neck flange	Type B1
805	DN250	PN100	EN 1092-1	F316/F316L	Weld neck flange	Type B2
806	DN250	PN160	EN 1092-1	F316/F316L	Weld neck flange	Type B2
810	8 in	CL150	ASME B16.5	F316/F316L	Weld neck flange	Raised face
811	8 in	CL300	ASME B16.5	F316/F316L	Weld neck flange	Raised face
812	8 in	CL600	ASME B16.5	A105 Carbon Steel	Lap joint flange	316/316L stub
813	10 in	CL150	ASME B16.5	F316/F316L	Weld neck flange	Raised face
814	10 in	CL300	ASME B16.5	F316/F316L	Weld neck flange	Raised face
815	10 in	CL600	ASME B16.5	F316/F316L	Weld neck flange	Raised face
816	10 in	CL600	ASME B16.5	A105 Carbon Steel	Lap joint flange	316/316L stub
817	10 in	CL600	ASME B16.5	F316/F316L	Weld neck flange	Raised face
818	8 in	CL600	ASME B16.5	F316/F316L	Weld neck flange	Raised face
819	8 in	CL900	ASME B16.5	F316/F316L	Weld neck flange	Raised face
820	10 in	CL900	ASME B16.5	F316/F316L	Weld neck flange	Raised face

CMFHC3Y (super duplex UNS S32750)

Code	Description					
825	DN200	PN40	EN 1092-1	Super duplex	Weld neck flange	Type B1
826	DN200	PN100	EN 1092-1	Super duplex	Weld neck flange	Type B2
827	DN200	PN160	EN 1092-1	Super duplex	Weld neck flange	Type B2
828	DN250	PN40	EN 1092-1	Super duplex	Weld neck flange	Type B1
829	DN250	PN100	EN 1092-1	Super duplex	Weld neck flange	Type B2
830	DN250	PN160	EN 1092-1	Super duplex	Weld neck flange	Type B2
831	8 in	CL150	ASME B16.5	Super duplex	Weld neck flange	Raised face
832	8 in	CL300	ASME B16.5	Super duplex	Weld neck flange	Raised face
833	8 in	CL600	ASME B16.5	Super duplex	Weld neck flange	Raised face
834	8 in	CL900	ASME B16.5	Super duplex	Weld neck flange	Raised face
836	10 in	CL150	ASME B16.5	Super duplex	Weld neck flange	Raised face
837	10 in	CL300	ASME B16.5	Super duplex	Weld neck flange	Raised face

Code	Description					
838	10 in	CL600	ASME B16.5	Super duplex	Weld neck flange	Raised face
839	10 in	CL900	ASME B16.5	Super duplex	Weld neck flange	Raised face

CMFHC4M (316L stainless steel)

Code	Description					
841	10 in	CL150	ASME B16.5	F316/F316L	Weld neck flange	Raised face
842	10 in	CL300	ASME B16.5	F316/F316L	Weld neck flange	Raised face
843	10 in	CL600	ASME B16.5	F316/F316L	Weld neck flange	Raised face
844	10 in	CL900	ASME B16.5	F316/F316L	Weld neck flange	Raised face
845	12 in	CL150	ASME B16.5	F316/F316L	Weld neck flange	Raised face
846	12 in	CL300	ASME B16.5	F316/F316L	Weld neck flange	Raised face
847	12 in	CL600	ASME B16.5	F316/F316L	Weld neck flange	Raised face
848	12 in	CL900	ASME B16.5	F316/F316L	Weld neck flange	Raised face
849	DN250	PN40	EN 1092-1	F316/F316L	Weld neck flange	Type B1
850	DN250	PN100	EN 1092-1	F316/F316L	Weld neck flange	Type B2
851	DN250	PN160	EN 1092-1	F316/F316L	Weld neck flange	Type B2
852	DN300	PN40	EN 1092-1	F316/F316L	Weld neck flange	Type B1
853	DN300	PN100	EN 1092-1	F316/F316L	Weld neck flange	Type B2
854	DN300	PN160	EN 1092-1	F316/F316L	Weld neck flange	Type B2

Case and hygienic options

Code descriptions

Code	Description
N	Standard case; 300-series stainless steel
D	Standard case; 300-series stainless steel; with rupture disk (either a single 0.5 in (13 mm) NPT male or a single 1 in (25 mm) NPT male, depending on line size)
P	Standard case; 300-series stainless steel; with one drain or two purge fittings <ul style="list-style-type: none"> ■ CMFS models have two 0.5 in (13 mm) female NPT drain fittings. ■ CMF350 and CMF400 models have two 1 in (25 mm) NPT female purge fittings. ■ All other models have two 0.5 in (13 mm) NPT female purge fittings.
M	316L stainless steel case
K	316L stainless steel case; with one drain or two purge fittings <ul style="list-style-type: none"> ■ CMFS models have two 0.5 in (13 mm) female NPT drain fitting ■ CMF350 and CMF400 models have two 1 in (25 mm) NPT female purge fittings ■ All other models have two 0.5 in (13 mm) NPT female purge fittings.

Code	Description
H	316L stainless steel case; hygienic finish: 32 Ra (0.8 µm) Flow Path Available only on the CMFS010M and CMFS015M, and with process connection codes 321, 344, 345 or 346.
R	316L stainless steel case with rupture disk (a single 0.5 in (13 mm) NPT male)

Codes available by model

Model	Available codes						
	N	D	P	M	K	H	R
CMFS***M/H/P	N	D	P	M	K	H ⁽¹⁾	R
CMF350M	N		P	M	K		
CMF350A	N	D		M			
CMF***M/L/H/P (not including models listed above)	N		P				
CMFHC***M/Y/A and CMF***A/B (not including models listed above)	N						

(1) 316L hygienic option available only on the CMFS010M and CMFS015M.

Electronics interface

Code descriptions

Code	Description
0	2400S transmitter
1	Extended mount 2400S transmitter
2	4-wire polyurethane-painted aluminum integral enhanced core processor for remote mount transmitters
3 ⁽¹⁾	4-wire stainless steel integral enhanced core processor for remote mount transmitters;
4	4-wire polyurethane-painted aluminum integral extended mount enhanced core processor for remote mount transmitters
5 ⁽¹⁾	4-wire extended mount stainless steel integral enhanced core processor for remote mount transmitters
6 ⁽²⁾	MVDSolo™; polyurethane-painted aluminum integral enhanced core processor (for OEMs); when ordered with approval C, A, Z, I, MVD Direct Connect™ I.S. barrier is supplied; not available with approval code U
7 ⁽¹⁾⁽²⁾	MVDSolo; stainless steel integral enhanced core processor (for OEMs); when ordered with approval C, A, Z, I, MVD Direct Connect I.S. barrier is supplied; not available with approval code U
8 ⁽²⁾	MVDSolo; extended mount polyurethane-painted aluminum integral enhanced core processor (for OEMs); when ordered with approval C, A, Z, I, MVD Direct Connect I.S. barrier is supplied
9 ⁽¹⁾⁽²⁾	MVDSolo; extended mount stainless steel enhanced core processor (for OEMs); when ordered with approval C, A, Z, I, MVD Direct Connect I.S. barrier is supplied
H ⁽³⁾⁽⁴⁾	9-wire extended mount polyurethane-painted aluminum junction box
J ⁽⁵⁾	2-wire integrally mounted 2200S transmitter; only available with calibration option C or K
M	For the integral mount standard finish FMT Filling transmitter (must order with FMT); must be ordered with FMT Filling transmitter, not sold separately

Code	Description
N	For the integral mount improved surface finish (64Ra) FMT Filling transmitter (must order with FMT); must be ordered with FMT Filling transmitter, not sold separately
R ⁽⁴⁾	9-wire polyurethane-painted aluminum junction box
S ⁽⁴⁾	9-wire 316L stainless steel junction box
T ⁽³⁾⁽⁴⁾	9-wire extended mount stainless steel junction box
U ⁽⁵⁾	2-wire extended 2200S transmitter; only available with calibration option C or K
F	For integral mount 5700 transmitter
Z	Other electronic interface (4200 transmitter) - requires a selection from Other electronics interface .

- (1) Not available with KH Special Test, and not recommended for truck mount.
- (2) When ordered with approval U, C, A, Z, I, P or R, MVD Direct Connect™ I.S. barrier is supplied.
- (3) Not available with approval T, S, L, 5 or J.
- (4) The junction box should not be insulated if the process temperature exceeds 300 °F (148.9 °C).
- (5) Only available with language code E (English).

Codes available by model

Model	Codes available																			
	F	U	T	S	R	N	M	J	H	Z	9	8	7	6	5	4	3	2	1	0
All stainless steel CMFS models (M) ⁽¹⁾	F	U	T	S	R	N	M	J	H	Z	9	8	7	6	5	4	3	2	1	0
All nickel alloy C22 CMFS models (H/P) ⁽¹⁾	F	U	T	S	R			J	H	Z	9	8	7	6	5	4	3	2	1	0
CMF200A/B, CMF300A/B, CMF400A/B				S	R								7	6			3	2		0
CMF350A ⁽¹⁾			T	S	R				H				7	6			3	2		0
CMFHC2M/Y, CMFHC3M/Y, CMFHC4M ⁽¹⁾			T	S	R				H		9	8	7	6	5	4	3	2	1	0
CMFHC2A, CMFHC3A													7	6			3	2		0
CMF010M/H/L/P, CMF025M/H/L, CMF050M/H/L, CMF100M/H/L		U	T	S	R			J	H	Z	9	8	7	6	5	4	3	2	1	0
CMF200M/H/L, CMF300 M/H/L, CMF350M/P ⁽¹⁾ , CMF400M/H/L/P		U	T	S	R			J	H		9	8	7	6	5	4	3	2	1	0

(1) Electronic interface codes R, S, H, or T is only available with the enhanced (800) core processor.

Conduit connections

Code descriptions

Code	Description
A	No gland with electronics interface codes 0, 1, C, J, M, N, R, S, or U. 3/4-NPT with no gland with any other electronics interface codes.
B	0.5 in (13 mm) NPT - no gland
E	M20 - no gland
F	Brass nickel cable gland (cable diameter 0.335 in (8.51 mm) to 0.394 in (10.01 mm))
G	Stainless steel cable gland (cable diameter 0.335 in (8.51 mm) to 0.394 in (10.01 mm))
H	Brass nickel cable gland
J ⁽¹⁾	Stainless steel cable gland
K ⁽²⁾	JIS B0202 1/2G - no gland
L ⁽²⁾	Japan - brass nickel cable gland
M ⁽²⁾	Japan - stainless steel cable gland
N ⁽²⁾	JIS B0202 3/4G - no gland
O ⁽²⁾	Japan - brass nickel gland
P ⁽²⁾	Japan - stainless cable gland
Model	with Electronics Interface code

(1) Not available with approval T, S, L, 5 or J.

(2) Only available with approval M, T, S, 5 and L.

Codes available by model

Model	With electronics interface code	Available codes													
		P	O	N	M	L	K	J	H	G	F	E	B	A	
All models	0, 1, J, C, M, N, U														A
CMF350P	H, T, R, S	P	O	N				J	H						A
CMFS (All except CMF5010M and CMF5015M), CMFHC2Y, CMFHC3Y	2, 3, 4, 5, 6, 7, 8, 9														
CMF200A/B CMF300A/B, CMF350A, CMF400A/B	6, 7														
CMFHC2M, CMFHC3M, CMFHC4M	6, 7, 8, 9									G	F	E	B		
CMF010M/L/H/P, CMF025M/L/H, CMF050M/L/H, CMF100M/L/H, CMF200M/L/H, CMF350M, CMF300M/L/H, CMF400M/H	H, T, 6, 7, 8, 9														

Model	With electronics interface code	Available codes													
		P	O	N	M	L	K	J	H	G	F	E	B	A	
CMF400P	H, T														
CMFS010M, CMFS015M	2, 3, 4, 5, 6, 7, 8, 9														
CMF200A/B CMF300A/B, CMF350A, CMF400A/B	2, 3														
CMFHC2A, CMFHC3A	2, 3, 6, 7														
CMFHC2M, CMFHC3M, CMFC4M	2, 3, 4, 5				M	L	K			G	F	E	B		
CMF010M/L/H/P, CMF025M/L/H, CMF050M/L/H, CMF100M/L/H, CMF200M/L/H, CMF300M/L/H, CMF350M	2, 3, 4, 5														
CMF350P, CMF400P	2, 3, 4, 5, 6, 7, 8, 9														

Approvals

Code descriptions

Code	Description
2	CSA (US and Canada): Class I, Division 2, Groups A,B,C,D
3	IECEX Zone 2
5	TIIS – T5 (IIC) Temperature Classification; not available for quotes outside of Japan; only available with electronic interface code R or S
6 ⁽¹⁾	ATEX - Equipment Category 2 (Zone 1, IIC modified) / PED compliant; models CMF200, CMF300, and CMF400 only
7 ⁽¹⁾	IECEX Zone 1, IIC modified; models CMF200, CMF300, and CMF400 only
8 ⁽¹⁾	NEPSI, IIC modified; only available with language option M (Chinese)
A	CSA (US and Canada): Class I, Division 1, Groups C and D
C	CSA (Canada only)
G	Country Specific Approval – Requires a selection from the Approvals section of the “Certificate, Tests, Calibrations and Services” model code option
I	IECEX Zone 1
J	Hardware ready for TIIS approval; requires conduit connection code E when used with electronics interface code 2, 3, 4, 5, Q, or A
M	Micro Motion Standard; no approval; no barrier included (if applicable)
N	Micro Motion Standard / PED compliant; no approval; no barrier included (if applicable)
P	NEPSI; only available with language option M (Chinese)

Code	Description
L	TIIS – T2 Temperature Classification; not available for quotes outside of Japan
S	TIIS – T3 Temperature Classification; not available for quote outside of Japan
T	TIIS - T4 Temperature Classification, not available for quote outside of Japan (for CMF models); Japan Ex zone 1 (for CMFS models)
V	ATEX - Equipment Category 3 (Zone 2) / PED compliant
Z	ATEX - Equipment Category 2 (Zone 1) / PED compliant
Models	With electronics interface code

(1) Models CMF200, CMF300, CMF400, CMFHC2, CMFHC3, and CMFHC4 are rated for Group IIB with standard ATEX approval code Z, IECEx approval code I, or NEPSI approval code P (where applicable). The IIC modification option (approval codes 6, 7, and 8) should be used only when necessary for the specific area classification.

Codes available by model

Model	With electronics interface code	Available codes																		
		Z	V	T	S	L	P	N	M	J	I	G	C	A	8	7	6	5	3	2
All	0, 1, M, N		V					N	M			G							3	2
CMFS007, CMFS025M/H/P, CMFS040M, CMFS050M/H/P, CMFS075M, CMFS100M/H/P, CMFS150M/H/P	2, 3, 4, 5, F	Z		T			P	N	M		I	G		A						2
	6, 7, 8, 9	Z					P	N	M		I	G		A						2
	J, U	Z	V	T				N	M		I	G		A					3	
CMFS010H/P, CMFS015H/P	2, 3, 4, 5	Z		T			P	N	M		I	G		A						
	J, U	Z	V	T				N	M		I	G		A					3	
CMFS010M/H/P, CMFS015M/H/P	6, 7, 8, 9	Z		T			P	N	M		I	G	C	A						
CMFS010M, CMFS015M	2, 3, 4, 5	Z		T			P	N	M		I	G		A						
	J, U	Z	V	T				N	M		I	G		A					3	
CMFS007, CMFS010M/H/P, CMFS015M/H/P CMFS025M/H/P, CMFS040M, CMFS050M/H/P, CMFS075M, CMFS100M/H/P, CMFS150M/H/P	R, S, H, T	Z					P	N	M		I	G		A						2
CMF010M/H/L, CMF025M/H/L, CMF050M/H/L, CMF100M/H/L, CMF010P	2, 3, 4, 5	Z		T	S	L	P	N	M	J	I	G		A						
	J, U	Z	V					N	M		I	G		A					3	
	A, R, S	Z	V	T	S	L	P	N	M	J	I	G	C	A				5	3	2
	H, T, W, D, 6, 7, 8, 9	Z					P	N	M		I	G	C	A						
CMF200M/H/L, CMF300M/H/L, CMF350M,	2, 3, 4, 5	Z		T	S	L	P	N	M	J	I	G		A	8	7	6			
	J, U	Z	V					N	M		I	G		A					3	

Model	With electronics interface code	Available codes																		
		Z	V	T	S	L	P	N	M	J	I	G	C	A	8	7	6	5	3	2
CMF400M/H/L, CMF350P ⁽¹⁾ , CMF400P ⁽²⁾	R, S	Z	V	T	S	L	P	N	M	J	I	G	C	A	8	7	6	5	3	2
	H, T, 6, 7, 8, 9	Z	V				P	N	M		I	G	C	A	8	7	6		3	2
CMF200A/B, CMF300A/B, CMF350A, CMF400A/B	2, 3, C, R, S	Z		T			P	N	M	J	I	G		A						
	6, 7	Z					P	N	M		I	G		A						
CMFHC2Y, CMFHC3Y	2, 3, 4, 5, 6, 7, 8, 9	Z					P	N	M		I	G		A		7	6			
CMFHC2A/M, CMFHC3A/M, CMFHC4M	2, 3, 4, 5	Z		T			P	N	M	J	I	G		A	8	7	6			
	6, 7, 8, 9	Z					P	N	M	J		G		A	8	7	6			

(1) Model CMF350P is not available with approval code T, S, L, J, or 5.

(2) Model CMF400P is only available with approval code U if it is ordered with electronics interface code H or T. Model CMF400P is only available with approval code T, S, or L if it is ordered with electronics interface code R, or S.

Languages

Code	Language option
A	Danish CE requirements document and English installation manual
D	Dutch CE requirements document and English installation manual
E	English installation manual
F	French installation manual
G	German installation manual
H	Finnish CE requirements document and English installation manual
I	Italian installation manual
J	Japanese installation manual
M	Chinese installation manual
N	Norwegian CE requirements document and English installation manual
P	Portuguese installation manual
S	Spanish installation manual
W	Swedish CE requirements document and English installation manual
B	Hungarian CE requirements document and English installation manual
K	Slovak CE requirements document and English installation manual
T	Estonian CE requirements document and English installation manual
U	Greek CE requirements document and English installation manual
L	Latvian CE requirements document and English installation manual
V	Lithuanian CE requirements document and English installation manual
Y	Slovenian CE requirements document and English installation manual

Calibration

There may be additional calibration options or model compatibility beyond what is shown below. For more information, contact a sales representative.

Code	Description ⁽¹⁾⁽²⁾
2 ⁽³⁾	0.05% mass flow and 0.0005 g/cm ³ (0.5 kg/m ³) density calibration
3 ⁽³⁾	0.05% mass flow and 0.0002 g/cm ³ (0.2 kg/m ³) density calibration
6 ⁽³⁾	0.05% mass flow and 0.002 g/cm ³ (2 kg/m ³) density calibration
D ⁽³⁾	0.10% mass flow and 0.0002 g/cm ³ (0.2 kg/m ³) density calibration
K	0.10% mass flow and 0.0005 g/cm ³ (0.5 kg/m ³) density calibration
C	0.10% mass flow and 0.002 g/cm ³ (2 kg/m ³) density calibration
Z	0.10% mass flow and 0.0005 g/cm ³ (0.5 kg/m ³) density calibration

(1) Accuracy levels apply to liquid only.

(2) Consult Factory for ISO 17025 accredited calibration with 0.014% reference uncertainty.

(3) Requires electronics interface code 0, 1, 2, 3, 4, 5, 6, 7, 8, or 9, or F.

Codes available by model

Model	Available codes						
	Z	C	K	D	6	3	2
CMFS007		C			6		
CMFS010, CMFS015		C	K				2
CMFS025, CMFS040, CMFS050, CMFS075, CMFS100, CMFS150			K	D		3	2
CMF010	Z						2
CMF025, CMF050, CMF100, CMF200H/L/M, CMF300H/L/M, CMF350M/P, CMF400H/M/P	Z			D		3	2
CMF200A/B, CMF300A/B, CMF350A, CMF400A/B,	Z						
CMFHC2, CMFHC3, CMFHC4	Z			D		3	2

Measurement application software

Code	Measurement application software option
A	Petroleum measurement; available only for CMFS models with electronics interface codes 6, 7, 8 and 9; for electronic interface codes 0, 1, 2, 3, 4, or 5, select the petroleum measurement software option on the transmitter
B ⁽¹⁾	Cryogenic application; includes remote enhanced core processor for direct host connection
C ⁽¹⁾	Cryogenic application; includes remote core processor for direct host connection
Z	No measurement application software

(1) Available only for CMF025M, CMF050M, and CMF100M models with electronics interface option R, conduit option A, and approval options M, P, or Z; not available with wafer process connections.

Factory options

Code	Factory option
Z	Standard product
X	ETO product
R	Restocked product (if available)

Certificates, tests, calibrations, and services

These option codes can be added to the end of the model code if needed, but no code is required when none of these options is selected.

There may be additional options or limitations depending on total meter configuration. Contact a sales representative before making your final selections.

Material quality examination tests and certificates

Select any.

Code	Factory option
SD	Super Duplex certification package (hydrostatic test certificate 3.1; material inspection certificate 3.1; ferrite test certificate 3.1; NACE certificate 2.1 MR0175); only available on CMFHC2Y–CMFHC3Y
MC	Material inspection certificate 3.1 (supplier lot traceability per EN 10204); not available separately on CMFHC2Y–CMFHC3Y
NC	NACE certificate 2.1 (MR0175 and MR0103); not available separately on CMFHC2Y–CMFHC3Y
KH	KHK package 3.1 (cert package to accommodate approval in Japan); only available on CMF025–CMF350 and CMF400B, but not available on CMF200B–CMF300B

Radiographic testing

Select only one from this group.

Code	Factory option
RE	X-ray package 3.1 (radiographic examination certificate; weld map; radiographic inspection NDE qualification)
RT	X-Ray package 3.1 (radiographic examination certificate with digital image; weld map; radiographic inspection NDE qualification)

Pressure testing

Select any from this group.

Code	Factory option
HT	Hydrostatic test certificate 3.1 (wetted components only); not available separately on CMFHC2Y–CMFHC3Y
PN	Pneumatic test certificate 3.1; only available on CMF025–CMF400 with base model codes H, P, L, or M
HE	Helium leak test certificate 3.1 (wetted components only)
SL	Sensitive leak test certificate 3.1 (case component only); only available on CMFS007 and CMFS025–CMFS150

Dye penetrant examination

Select any from this group.

Code	Factory option
D1	Dye penetrant test package 3.1 (process connection only; liquid dye penetration NDE qualification)
D2	Dye penetrant test package 3.1 (case only; liquid dye penetration NDE qualification)

Weld examination

Code	Factory option
WP	Weld procedure package (weld map, weld procedure specification, weld procedure qualification record, welder performance qualification)

Positive material testing

Select only one from this group.

Code	Factory option
PM	Positive material test certificate 3.1 (without carbon content)
PC	Positive material test certificate 3.1 (including carbon content); only available on sensors with base model code M, L, or A

Special cleaning

Code	Factory option
O2	Declaration of compliance oxygen service 2.1; not available on CMFHC2–CMFHC4

Accredited calibration

Select only one from this group.

Code	Factory option
IC	ISO17025 accredited calibration and certificates (9 points total)
BB	MID Calibration for Marine Bunkering; no printer; only available on CMFHC3M with electronics interface code 2–5 and calibration code Z; not available with any other add-on options for special test or calibration

Density calibration

Code	Factory option
DT	Density temperature calibration (only available with “Calibration option” codes D and 3)

Special calibration options

Select either none, CV, or CV with one of the additional verification point options.

Code	Factory option
CV	Custom verification (alter original verification points)
01	Add one additional verification point
02	Add two additional verification point
03	Add three additional verification point
06	Add up to six additional verification points
08	Add up to eight additional verification points
16	Add up to 16 additional verification points

Weights & Measures

Code	Factory option
WM	Tag for US NTEP certified applications
WC	Tag for Measurement Canada certified applications

ASME B31.1 Power Piping design code certification

Code	Factory option
GC	B31.1 Power Piping design code certification

Sensor completion

Select any from this group.

Code	Factory option
WG	Witness general
SP	Special packaging

Instrument tagging

Code	Factory option
TG	Instrument tagging – customer information required; maximum 24 characters

Additional hardware

Code	Factory option
PK	2 in (51 mm) Pipe Mount U-Bolt Kit for electronics; only available on CMF025M, CMF050M, and CMF100M (with measurement application code C) and on CMF200A/B–CMF400A/B and CMFHC2A–CMFHC3A (with any measurement application code)

Country specific approvals

Select one from the following if approval code G is selected.

Code	Factory option
R1	EAC Zone 1 – Hazardous Area Approval ⁽¹⁾⁽²⁾
R2	EAC Zone 1 - IIC modified - Hazardous Area Approval ⁽¹⁾⁽²⁾
R3	EAC Zone 2 – Hazardous Area Approval ⁽¹⁾ Available only with electronics interface code 0, 1, J, or U.
B1	INMETRO Zone 1 - Hazardous Area Approval ⁽¹⁾⁽²⁾
B2	INMETRO Zone 1 - IIC modified - Hazardous Area Approval ⁽¹⁾⁽²⁾
B3	INMETRO Zone 2 – Hazardous Area Approval ⁽¹⁾

- (1) Only available with approval code G.
- (2) Not available with electronics interface code 0 or 1.

Other electronics interface

Code	Factory option
UA	4200 integral mount aluminum housing

Emerson Automation Solutions

Worldwide Headquarters
7070 Winchester Circle
Boulder, Colorado USA 80301
T: +1 800-522-6277
T: +1 303-527-5200
F: +1 303-530-8459
Mexico: +52 55 5809 5300
Argentina: +54 11 4837 7000
Brazil: +55 15 3413 8000
Chile: +56 2 2928 4800
Peru: +51 15190130

Emerson Automation Solutions

Central Europe: +41 41 7686 111
Eastern Europe: +41 41 7686 111
Dubai: +971 4 811 8100
Abu Dhabi: +971 2 697 2000
Austria: +43 2236 607-0
France: +33 (0) 800 917 901
Germany: +49 (0) 2173 3348 0
Italy: +39 8008 77334
The Netherlands: +31 318 495 555
Belgium: +32 2 716 77 11
Spain: 900 901 983
U.K. and Ireland: 0870 240 1978
Russian/CIS: +7 495 995 9559

Emerson Automation Solutions

Australia: (61) 3 9721 0200
China: (86) 21 2892 9000
India: (91) 22 6662 0566
Japan: (81) 3 5769 6803
South Korea: (82) 31 8034 0000
Singapore: (65) 6 363 7766

©2020 Micro Motion, Inc. All rights reserved.

The Emerson logo is a trademark and service mark of Emerson Electric Co. Micro Motion, ELITE, ProLink, MVD and MVD Direct Connect marks are marks of one of the Emerson Automation Solutions family of companies. All other marks are property of their respective owners.